

# Wattr Installation Guide



**wattr**

.....	<b>1</b>
<b>1.    <b>Introductie</b> .....</b>	<b>4</b>
<b>1.1.    <b>Sempl</b> .....</b>	<b>4</b>
<b>1.2.    <b>Wattr</b> .....</b>	<b>4</b>
<b>2.    <b>Productomschrijving</b> .....</b>	<b>5</b>
<b>3.    <b>Functionaliteiten</b> .....</b>	<b>6</b>
<b>3.1.    <b>Warmtepomp-aansturing</b>.....</b>	<b>6</b>
<b>3.2.    <b>Circulatiepomp-aansturing</b>.....</b>	<b>7</b>
<b>3.3.    <b>Verlichting</b>.....</b>	<b>8</b>
<b>3.4.    <b>Overzicht waterkwaliteit</b> .....</b>	<b>9</b>
<b>3.5.    <b>Terugspoelen</b> .....</b>	<b>Fout! Bladwijzer niet gedefinieerd.</b>
<b>3.6.    <b>Overloop</b>.....</b>	<b>Fout! Bladwijzer niet gedefinieerd.</b>
<b>3.7.    <b>Niveauregeling</b>.....</b>	<b>12</b>
<b>3.8.    <b>Aansturing afdekking</b> .....</b>	<b>12</b>
<b>3.9.    <b>Slimme modus (alleen met abonnement)</b>.....</b>	<b>14</b>
<b>3.9.1.    <b>Koppeling met ems-systemen</b> .....</b>	<b>18</b>
<b>3.10.   <b>Energie-inzichten</b> .....</b>	<b>18</b>
<b>3.11.   <b>Slimme notificaties</b> .....</b>	<b>19</b>
<b>3.12.   <b>Gebruikersprofielen en delen van systemen</b>.....</b>	<b>20</b>
<b>3.12.1.    <b>Beheerder vs gebruiker</b> .....</b>	<b>20</b>
<b>3.12.2.    <b>Bedrijfsaccounts</b> .....</b>	<b>21</b>
<b>4.    <b>Connectors</b> .....</b>	<b>24</b>
<b>4.1.    <b>Plaatsing</b>.....</b>	<b>24</b>
<b>4.2.    <b>Feed</b>.....</b>	<b>Fout! Bladwijzer niet gedefinieerd.</b>
<b>4.3.    <b>Relais Contacten</b> .....</b>	<b>24</b>
<b>4.4.    <b>Modbus RTU (RS 485)</b>.....</b>	<b>24</b>
<b>4.5.    <b>Ethernet</b>.....</b>	<b>25</b>
<b>4.6.    <b>Input contacts</b>.....</b>	<b>25</b>
<b>4.7.    <b>Temperatuur sensoren</b> .....</b>	<b>25</b>
<b>5.    <b>Aansluiting apparaten</b>.....</b>	<b>26</b>
<b>5.1.    <b>Warmtepomp</b> .....</b>	<b>26</b>
<b>5.1.1.    <b>Fairland/Aquark heat pump</b> .....</b>	<b>26</b>
<b>5.1.2.    <b>PHNIX heat pump</b>.....</b>	<b>27</b>
<b>5.2.    <b>Waterbehandeling</b> .....</b>	<b>27</b>

5.2.1.	Verbinding met behulp van RS485 Modbus .....	27
	<b>Verbinding Sugar Valley, Da-Gen, Aqua Easy Station .....</b>	<b>27</b>
	<b>Idegis.....</b>	<b>29</b>
5.2.2.	Draadloze verbinding.....	30
<b>5.3.</b>	<b>Circulatiepomp .....</b>	<b>32</b>
5.3.1.	Besturing met potentiaalvrije contacten .....	32
5.3.2.	Besturing met Modbus RS-485 .....	33
<b>5.4.</b>	<b>Afdekking.....</b>	<b>33</b>
5.4.1.	Status uitlezen .....	33
5.4.2.	Aansturen van de afdekking .....	34
<b>5.5.</b>	<b>Aansluiting verlichting.....</b>	<b>35</b>
5.5.1.	Met behulp van relais-contacten .....	35
5.5.2.	Met behulp van RS485.....	36
<b>5.6.</b>	<b>Aansluiting Besgo-kleppen .....</b>	<b>37</b>
<b>5.7.</b>	<b>Aansluiting waterniveau-regeling .....</b>	<b>38</b>
<b>5.8.</b>	<b>Aansluiting andere toestellen.....</b>	<b>39</b>
<b>5.9.</b>	<b>Configuatie in app .....</b>	<b>39</b>
<b>5.10.</b>	<b>Installatie delen .....</b>	<b>43</b>
<b>5.11.</b>	<b>Warmtepompen .....</b>	<b>45</b>
<b>5.12.</b>	<b>Waterbehandelingsystemen .....</b>	<b>45</b>
<b>5.13.</b>	<b>RGB-sturingen lampen (kleurenwiel).....</b>	<b>45</b>

# 1. Introduction

## 1.1. Sempl

Sempl is a Belgian company specializing in thermal/energetic modeling and optimization. With this knowledge, Sempl's mission is to facilitate today's energy transition. This is because we are increasingly using renewable energy and electrifying more and more equipment, which brings both opportunities and challenges. Conventional controls are not adapted to this, so there is room for improvement in control and energy savings. Sempl taps into this potential by offering advanced controls that use thermal/energy modelling to make optimal use of (renewable) energy.



## 1.2. Wattr

Wattr is the brand name of Sempl's swimming pool control system. Wattr is a revolutionary, self-learning and also user-friendly pool controller. Wattr communicates with the devices present in your swimming pool installation, such as your heat pump, circulation pump, water treatment, automatic cover, etc. and brings together the control of these devices in one convenient application.

Thanks to the use of unique self-learning thermal/energy models of your pool, Wattr can also actively optimize your energy consumption when the "Smart Mode" is activated. Wattr takes into account your comfort requirements, the performance of your heat pump, weather forecasts and much more. When linked to a household energy management/home automation system, the consumption of your swimming pool can also be adjusted to the consumption of your household, the production of your solar panels, dynamic energy tariffs, etc. The possibilities are endless.





## 2. Product Description

Wattr, an intelligent pool controller, allows you to centrally control all the devices of the pool installation using a single application. Thanks to self-learning models and algorithms, it is also possible to save significantly on your energy costs when activating the smart mode.

Wattr consists of a hardware module that is placed in the form of a Din rail module in the electrical box of your swimming pool. This hardware module is equipped with various inputs and outputs to enable communication with the equipment present. Thanks to multi-function inputs and outputs, the Wattr module can be used to control different devices in different combinations.

Everything is presented visually and is easy to operate in the Wattr app, available for Android and IOS. The app is also a useful tool for the installer to perform the configuration of a module and then share it with the customer.

Wattr has several functionalities, the most important of which are listed below.

In combination with a compatible heat pump using the Modbus RTU (RS485) protocol, Wattr can provide the energy control for the heat pump. For example, Wattr takes into account the characteristics of your specific heat pump to ensure that you can achieve your swimming comfort with the lowest possible energy costs. By collecting data, Wattr also learns installation-specific characteristics, such as recognising when the heat pump is in the shade and is less efficient, in order to respond to this in control.

Wattr can also communicate with water treatment systems equipped with the Modbus RTU (RS485) protocol. The module recognizes the connected sensors and then visualizes the relevant data in the app, when the water treatment system also acts as a filtration control, Wattr will also make these functionalities usable from the app. In this way, Wattr can ensure that the water quality is not compromised.

When the water treatment system is not equipped with filtration control, the Wattr module can be used to control a variable speed circulator using the relay outputs, if a compatible circulator is equipped with the Modbus RTU protocol (RS 485), it can also be used to control the pump.

The relay contacts can also be used to configure backwash functions, overflow control, simple water level control, lighting control and much more. Details of these functionalities can be found in this document.

The module is also equipped with input contacts. These are used, for example, to read the cover (open or closed), a float contact for regulating the water level.

### 3. Functionalities

Below is a summary of the various functionalities of the Watrr controller.

#### 3.1. Heat pump control

The Watrr module communicates with the heat pump in every installation. This ensures that the heat pump can be controlled from the Watrr application. It allows you to set the desired temperature directly on the heat pump from the Watrr application using the circular slider on the home screen. You can also directly read the current water temperature and check the current operating capacity of your inverter heat pump. In the circle at the top, there is also a button with which you can switch the heat pump on or off.

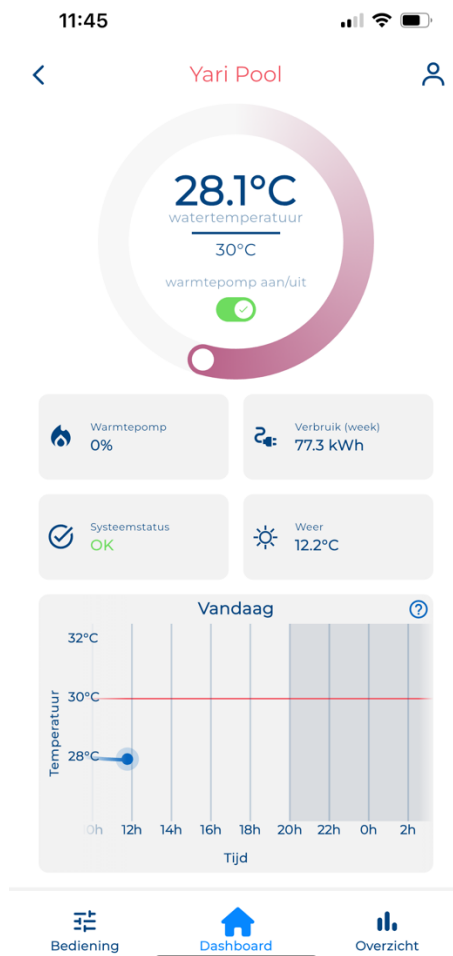

## 3.2. Circulation pump control

From the Watrr application, you can set the filtration intervals and corresponding filtration rates of your pump. The pump is controlled directly by the Watrr module or by a connected water treatment device.

The filter menu can be found under "control".

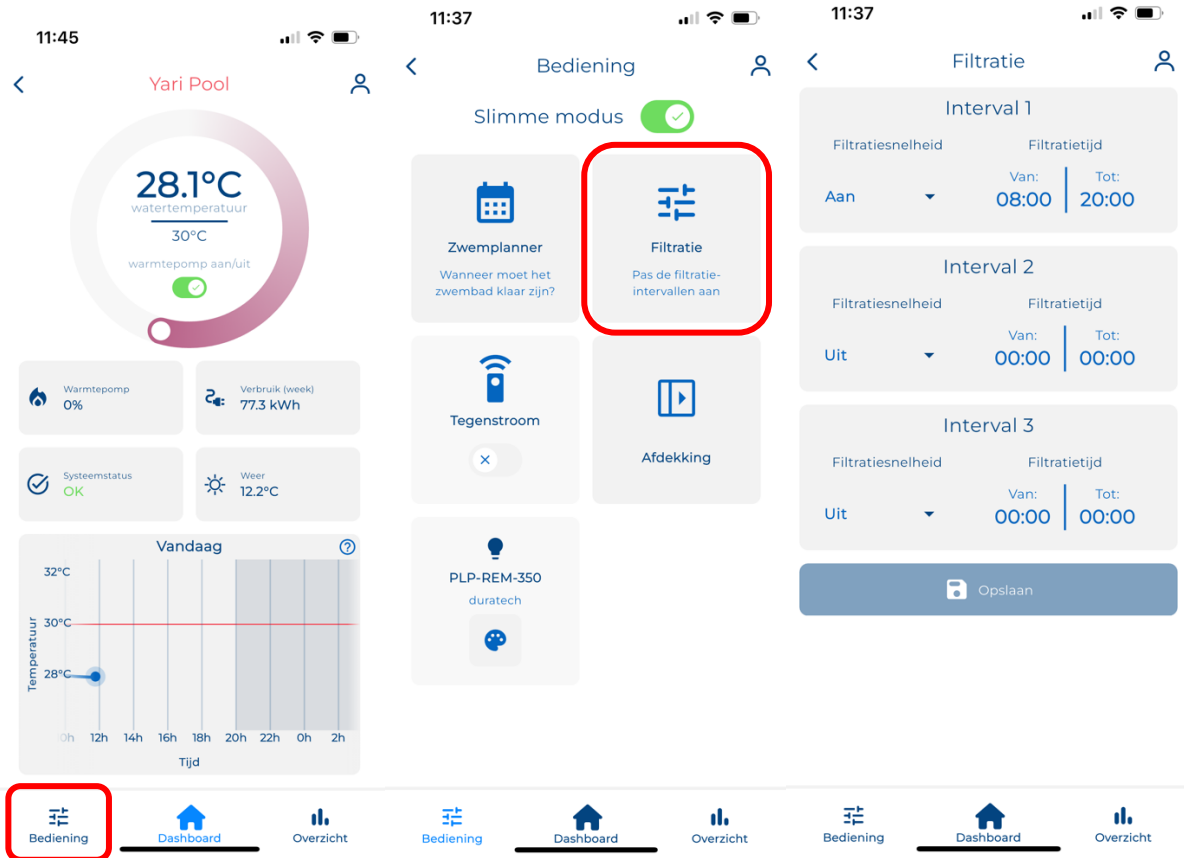

### Attention

Always ensure sufficient hours of filtration to ensure water quality. Please respect local laws for this as well. Always set the speeds/pump speeds of your pump high enough for this purpose.

### 3.3. Lighting

When lighting is connected to the Wattr module, it can be controlled from the Wattr application. Depending on the brand and type of lighting, there are different options. For example, the lights can be turned on/off with a button or changed color with a button. With certain lamps, a color wheel can also be used in the app to control the colors.

Below is an example of the on/off control of the lighting.

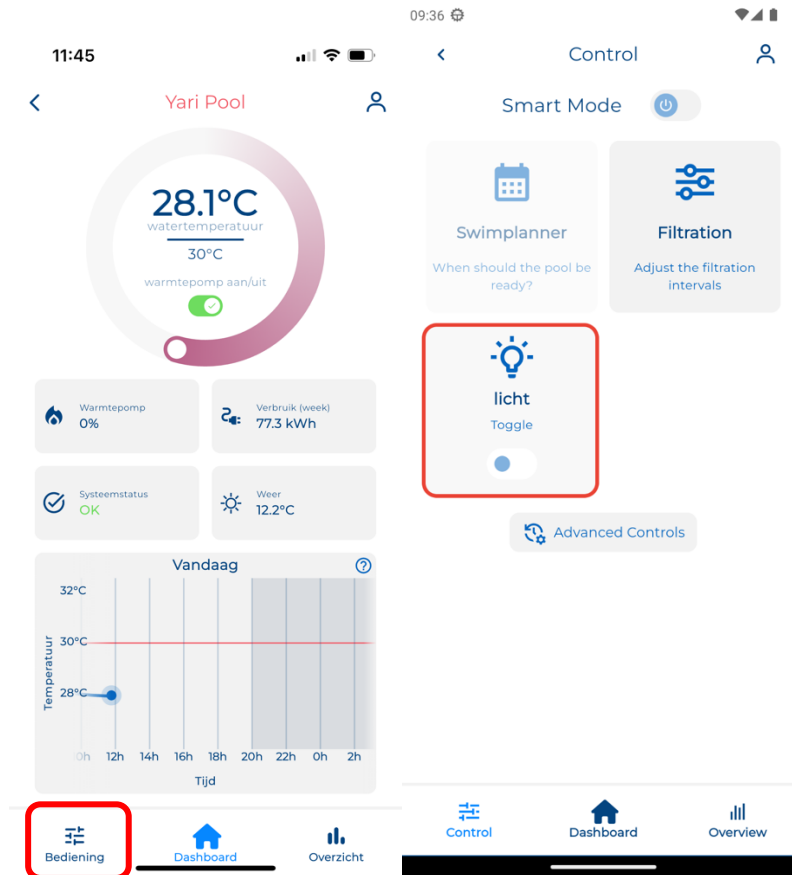

The following is an example of operation using a color wheel with RS485 compatible lighting. By pressing the buttons at the top, you can switch the lighting on/off. Use the buttons below to choose white or colored light.

When selecting a color, you can use the color wheel, for this you drag the white button over the desired color. When a color has been successfully chosen, this color also appears in the center of the circle. You can use the slider at the bottom of the control menu to adjust the brightness of your lighting.

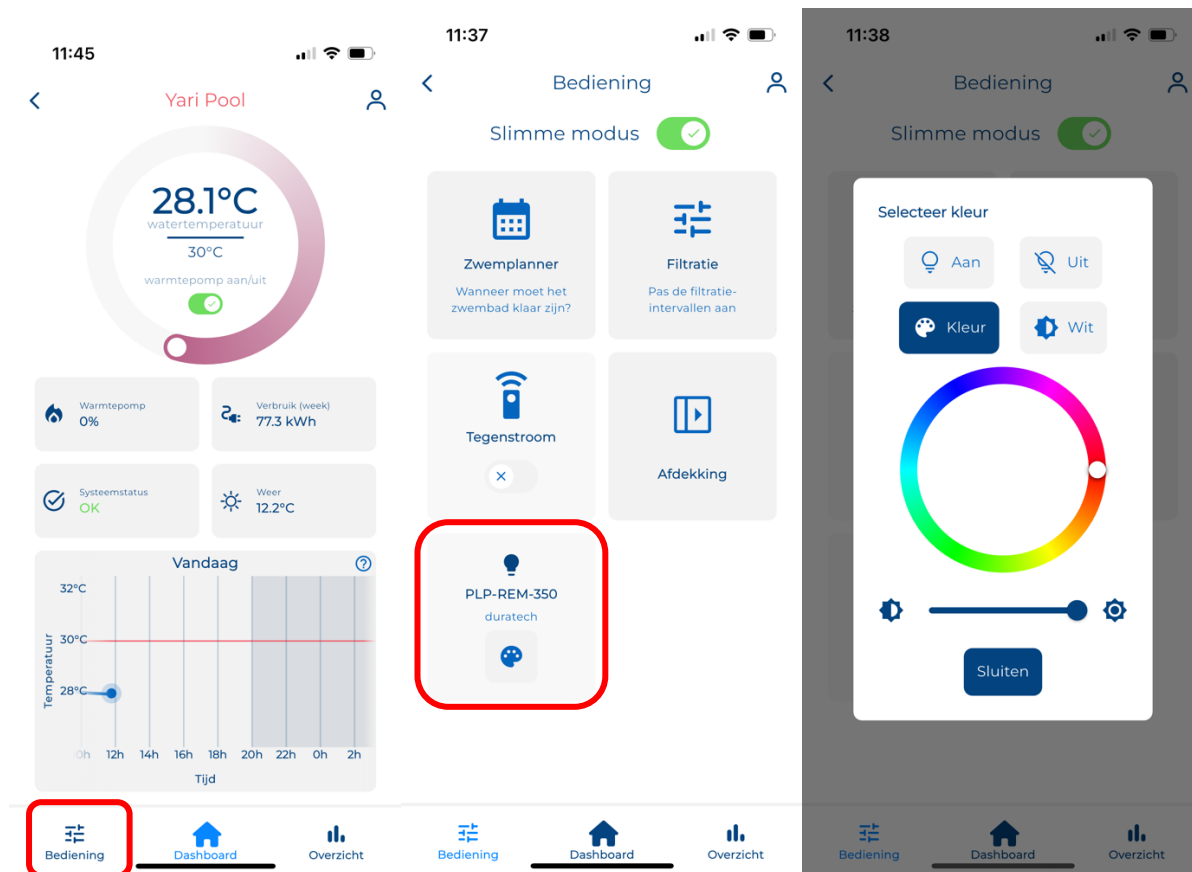

## Attention

Whether or not you can set colors depends on the installed lighting and the connection to the Wattr module. The last page of this document lists the compatible lighting controls.

## 3.4. Water quality overview

When a compatible water treatment device is connected to the Wattr controller, the water quality is also tracked in the application. This allows Wattr to detect any problems early. The Wattr module detects which sensors are present in your water treatment device and visualizes the relevant measured values.

## Attention

If you do not have a compatible water treatment device, you can still use the Wattr controller. The water values will then not be reflected on the home screen and in the overview page.



### 3.5. Backwash

When the Wattr controller is equipped with a backwash valve, you can manually or automatically backwash from the Wattr application. The backwash control can be found in the filtration menu. Backwashes can be scheduled using a timer. You can also use the "Backwash Now" button to start a backwash right away. With automatic backwashing, you can set what day, what time of day, and how long the backwash should occur. You can also set the frequency with which this automatic backwashing should repeat.

#### Attention

Always verify that the "enabled" button is enabled when you want the system to operate according to the automatic backwashing schedule as set with the timers.

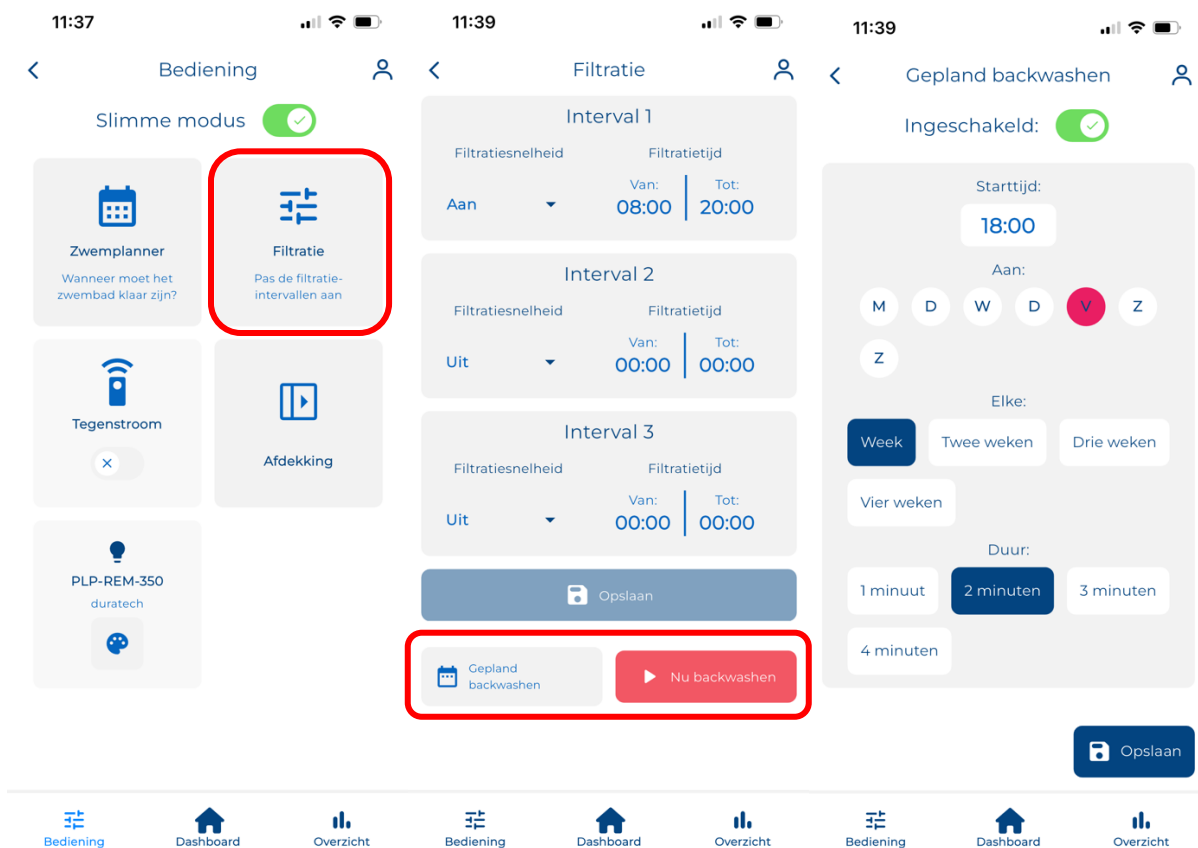

### 3.6. Overflow

For infinity pools equipped with a buffer tank, the Watrr module can control the overflow valve. For example, timers can be used to set at what times of the day the overflow should be activated and the filtration should take place from the buffer tank. At other times, filtration takes place from the bottom of the pool, without overflow. Switching between bottom inlet and overflow operation can save a significant amount of energy associated with additional heat losses during overflow operation. In smart mode, the Watrr module automatically takes into account additional heat losses during overflow operation in order to anticipate this with the heat pump.

#### Attention

Always verify that the "enabled" button is enabled when you want the system to operate according to the automatic overflow schedule as set with the timers. When this button is set to "off", the set timers will not be used and the overflow operation will not be activated.

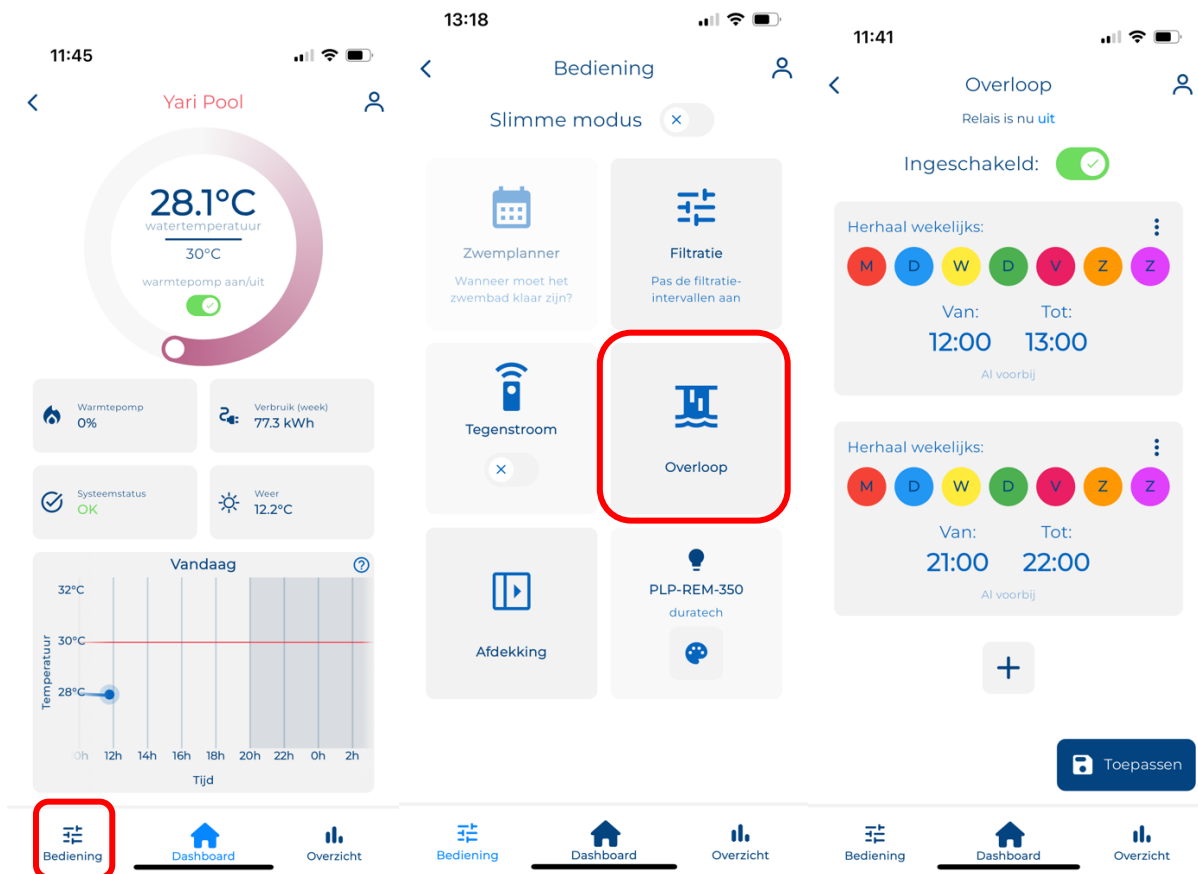

### 3.7. Level control

When configured, the Wattr module can be set to perform simple level control. This uses a float switch that is placed near the pool (e.g. in a skimmer) and connected to an input from the Wattr module. Depending on the contact generated with a float, Wattr receives the signal that the water level is too low, for example, with the help of a relay contact, the solenoid valve is switched on for refilling. The Wattr controller is also equipped with a fault detection system. If the pool needs to be refilled too often or for too long, the Wattr control will stop refilling and report the detected error. A pre-programmed delay avoids excessive switching of the relay contact when water is in motion.

### 3.8. Controlling the cover

Automatic covers that allow the cover to be operated with pulses can be controlled using Wattr. 1 of the Wattr contacts emits pulses that cause the cover to open – stop – or close, depending on the status at the time of control.

To protect against accidental or unauthorized operation of the cover, a PIN code is set. This PIN code must be entered correctly before the slider activates the operation of the cover. It is always necessary to check visually if it is safe to operate the cover before activating the cover!



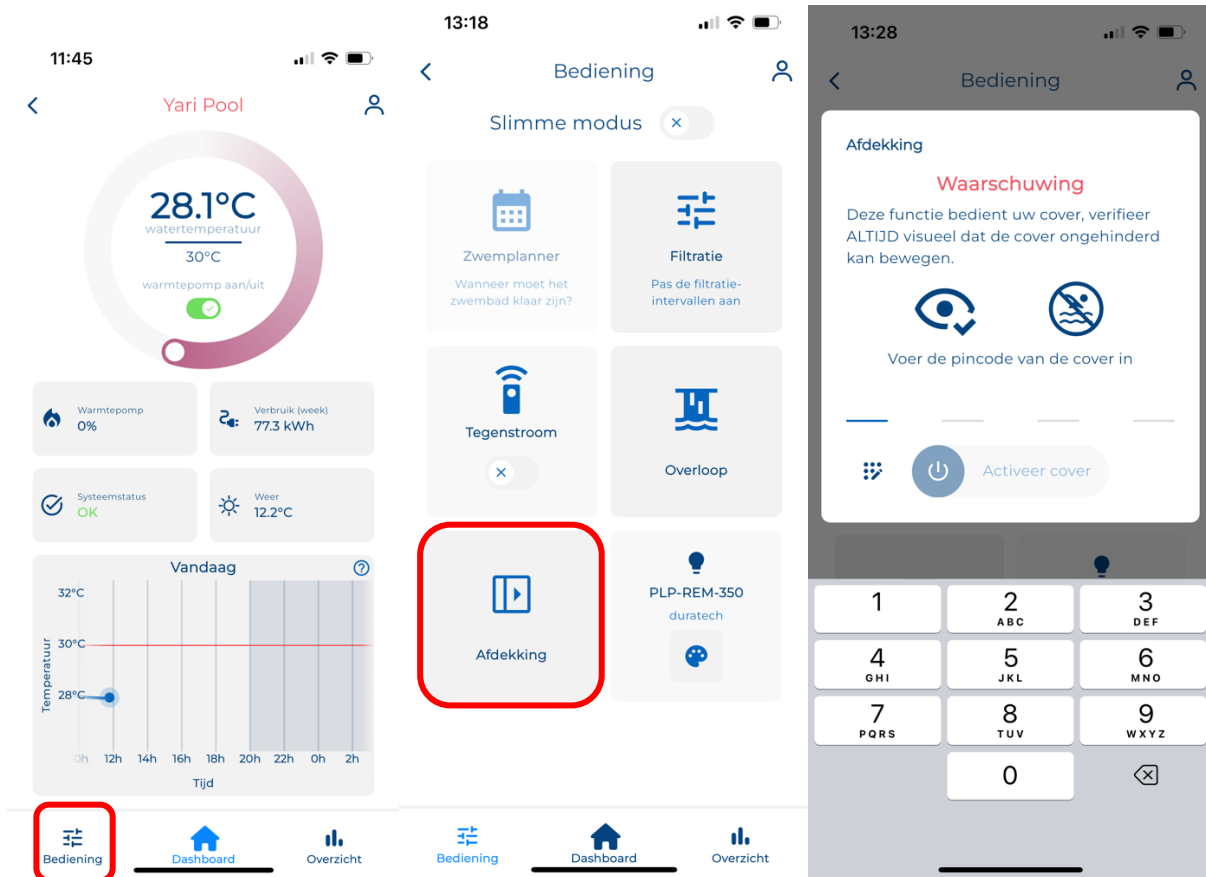

Here's how to set up the PIN:

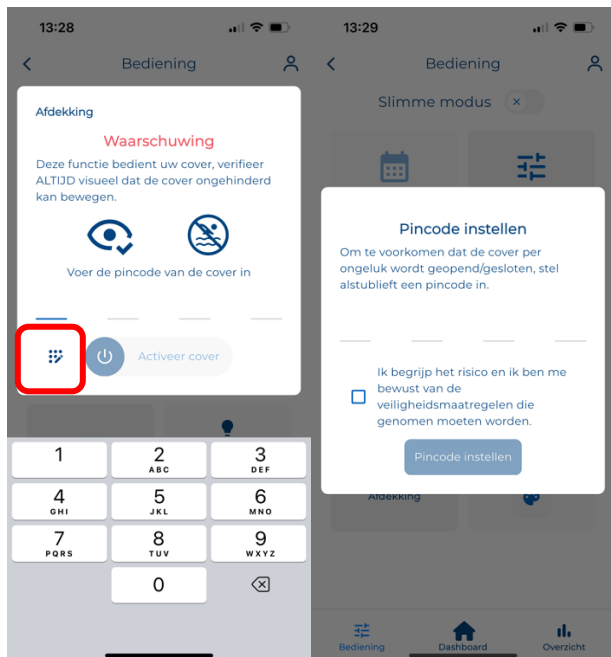

## Attention

Always check the manual of the cover you wish to control to check its steering behaviour by means of pulses.

## Attention

Controlling the cover using Wattr is entirely at your own risk. The user must always be aware that a visual confirmation with the pool is required to ensure safe operation!

## Attention

Before controlling the cover using Wattr, it must be verified if local regulations allow it! Wattr is not responsible for violations of local regulations.

## Attention

Please note that only administrators have permission to set/modify the PIN code for operation of the cover.

### 3.9. Smart Mode (with subscription only)

The Wattr module can do energy management for your pool by using self-learning thermal models and predictive algorithms. In this mode, Wattr takes over the control of your heat pump, while you only have to indicate when and what comfort you want.

Smart mode can be enabled in the control menu, as shown below.

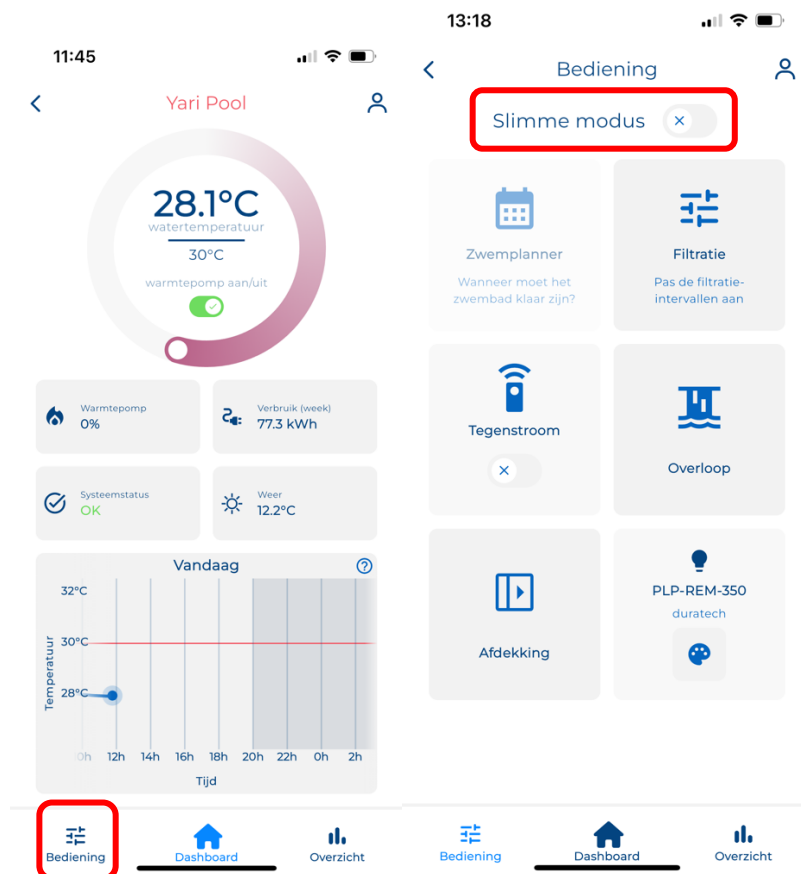

After enabling smart mode, the home screen circular temperature slider will be adjusted. 2 temperatures can be set here: your comfort temperature and a minimum temperature. The comfort temperature is the temperature you wish to reach at the indicated swimming times. The minimum temperature is the temperature above which the system must remain.

In smart mode, you have to specify the times you want to swim or usually swim. This is done with the help of the so-called "swimming planner", which can also be found in the "operation" menu. Here you always have the choice to schedule a single swimming moment or a recurring swimming moment. For example, you can specify that every weekend from 2:00 p.m. to 5:00 p.m. is a swimming time.

Within the swim planner you can also use the so-called "energy slider". This slider indicates the extent to which the controller is allowed to deviate the water temperature from the comfort temperature at times when no swimming moments are planned. When the slider is fully to the left, the system always tries to maintain the comfort temperature, when it is moved to the right the system can cause the temperature to vary between the comfort temperature and the minimum temperature, but at swimming times the system still aims for the comfort temperature. You can typically expect more savings if the energy slider is shifted to the right, but even if it's shifted to the left, the system will still calculate the most efficient way to heat.

Below are some screenshots of the Wattr application to indicate how such things can be set up. Here you will see that a swimming moment is set on Thursday, Friday, Saturday and Sunday from 5 p.m. to 7 p.m. The energy slider is set to predominantly eco, which gives wattr permission to lower the temperature to the minimum temperature where advantageous.

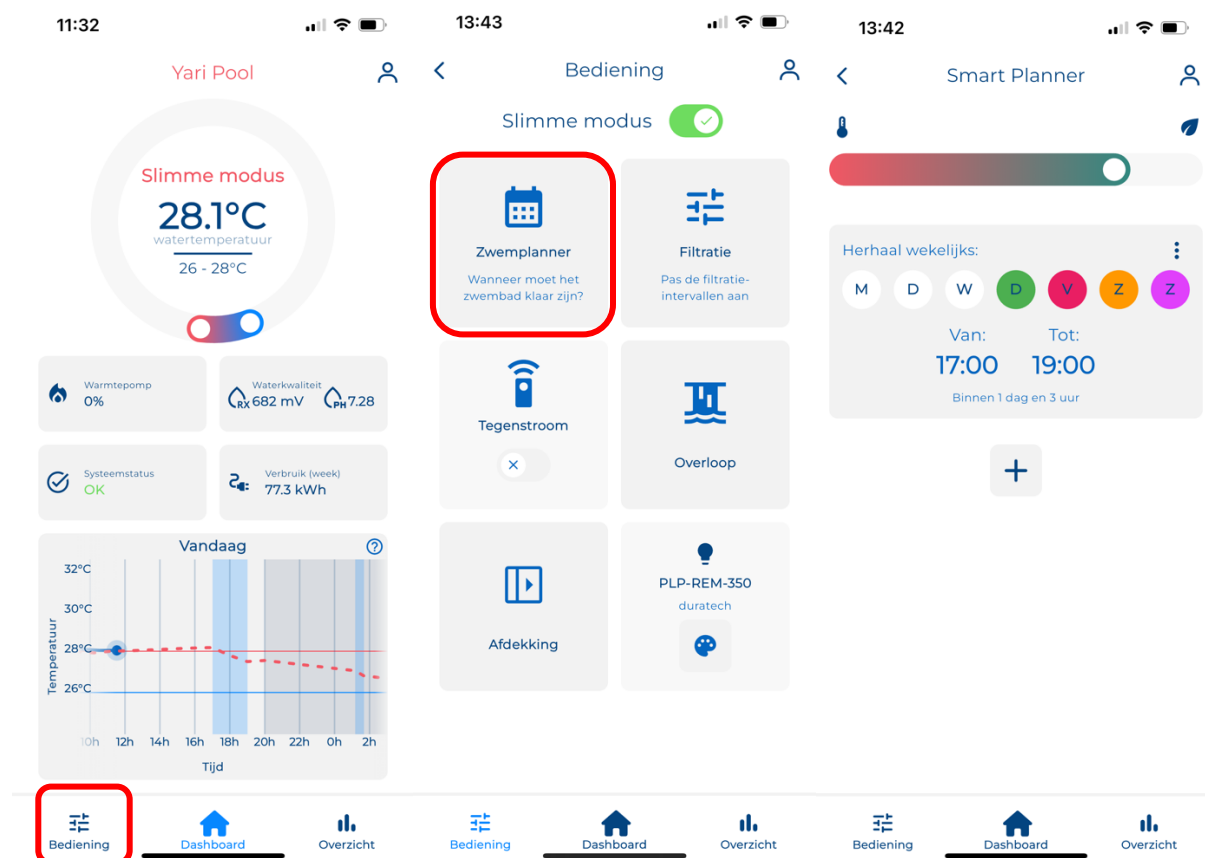

When the + button is pressed, you can add a swimming moment, you can then choose whether this should be a one-time swimming moment or if this swimming moment should be repeated weekly.

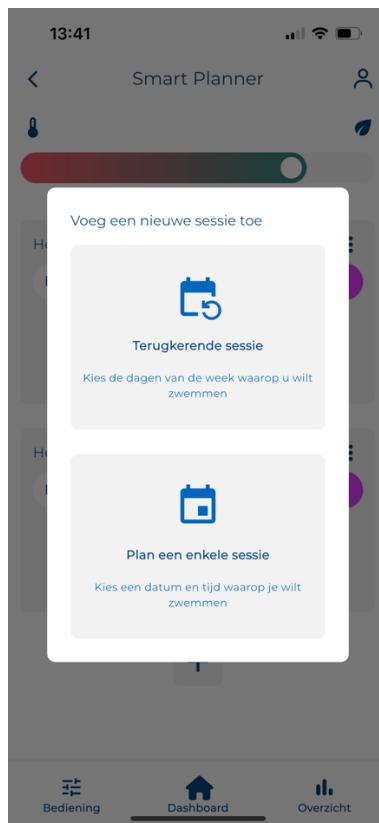

The smart mode looks at weather forecasts, planned swimming times, expected yields of PV installations, expected consumption peaks of your household, etc. To work with your pool's self-learning thermal model to determine when and how hard the heat pump should run to provide optimal comfort at the lowest possible energy cost. To this end, the controller makes periodic predictions, which can also be consulted in the application. They also show the expected savings for the coming week (compared to the standard heat pump control where the setpoint is equal to the comfort temperature) and the deviation from the last forecast. If the deviation increases, for example due to an unexpectedly long opening of the pool, the system automatically corrects itself.

In the home screen, you can always recognize the smart mode by the temperature forecast that is visible in dotted lines. The indicated swimming moments are indicated in blue, also the moments when the circulation pump is not active are indicated in the graphs.

Details of how hard the heat pump has been running can be found by pressing "heating" in the overview page. This tile also indicates the current temperature difference between the forecast and the actual measured value. At the bottom of the overview page you can always see how long it has been since a new prediction/optimization was performed. If the difference between the measured and predicted value becomes too large, Wattr corrects itself by performing a new prediction/optimization.

Details about your energy consumption (and any energy savings) can be found by clicking on "energy" on the overview page.

At the bottom of the overview page, it is always shown when the last prediction/optimization was executed.

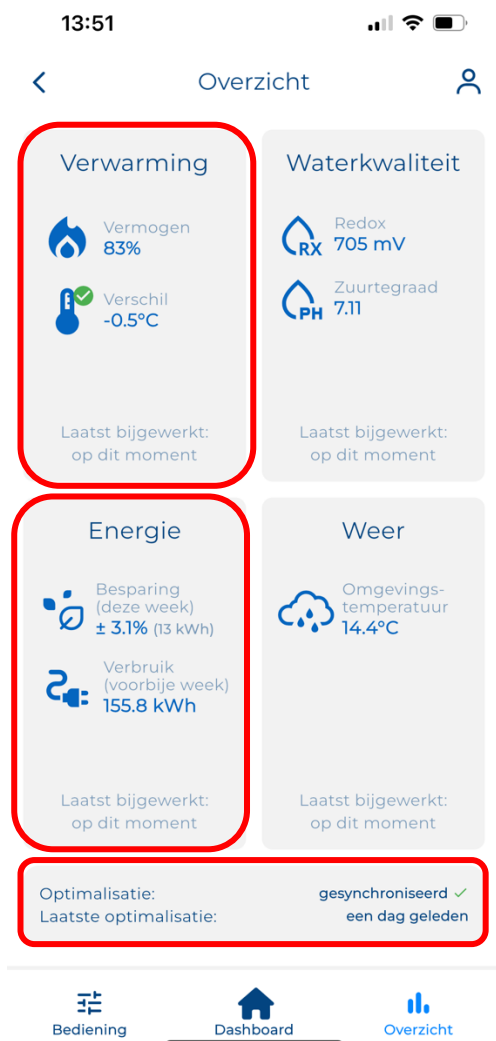

### Remark

The potential savings are highly dependent on pool use and environmental factors. For example, it is highly recommended to always cover the pool when not in use.

### Remark

Potential savings also depend on the choice of equipment, some devices allow for more detailed operation and can provide more savings than others.

### Remark

The algorithm already uses predictions of solar energy to adjust the operation to the maximum. A so-called "standard load profile" is used from which wattr obtains general information about when to avoid consuming a lot of electricity. This helps to avoid peak consumption at household level. An integration with an EMS system or digital meter is therefore not necessary, but with such integrations, wattr has more detailed information that allows the operation to be optimized even further.

### 3.9.1. Connection to EMS systems

Wattr can be connected to certain EMS systems. Wattr uses the information from the EMS system to adjust its own optimizations and control. For example, in the event of overproduction of the solar panels, this can be responded to directly, but wattr can also be slowed down when too much energy is drawn from the grid and too many appliances are used in the household at the same time.

## 3.10. Energy Insights

By clicking on energy in the overview page, you can consult insights regarding the energy consumption of the heat pump. If Smart Mode was also used, a comparison is available with respect to not using Smart Mode.

At the top, you can select the time scale on which you want to consult the graph with the energy data. Declared energy costs/savings expressed in EUR depend on the kWh/price set. You can adjust this at the bottom of the page if desired.

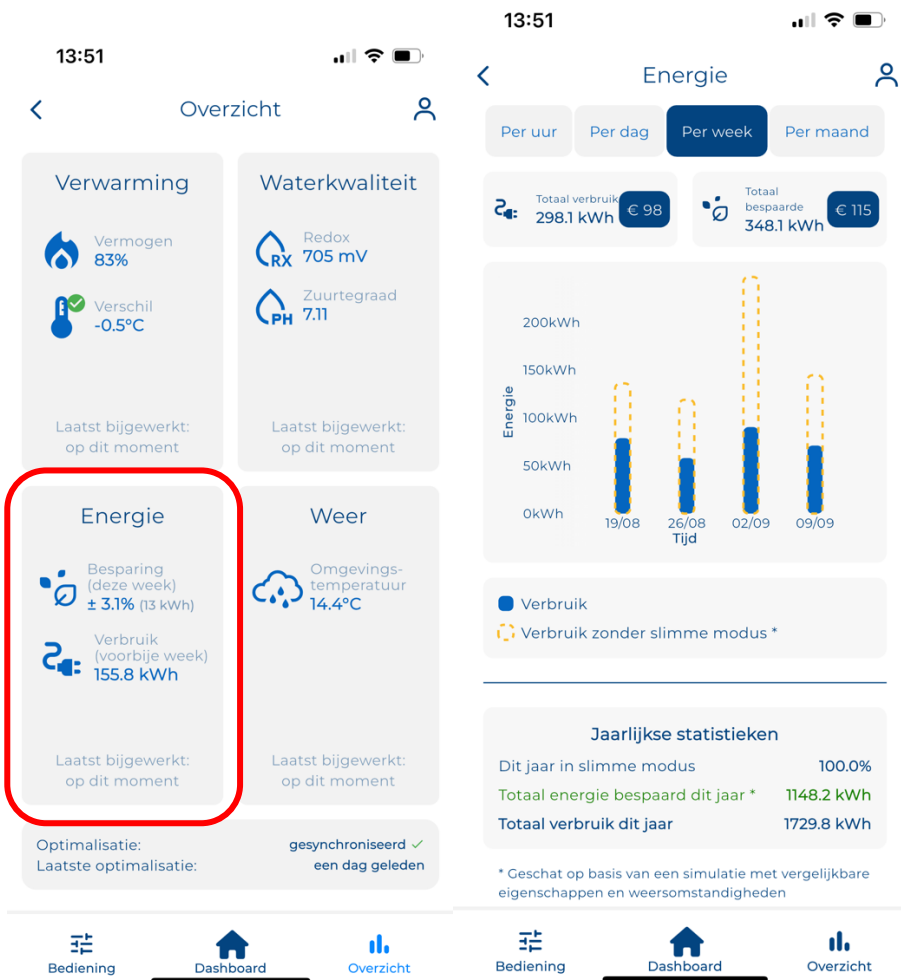

### Attention

The indicated savings in smart mode are based on a comparison made by simulating not using smart mode. A simulation is always an approximation of reality and can therefore not be interpreted as exact, this comparison is only to give an indication of your savings.

### 3.11. Smart notifications

Wattr communicates with the various equipment connected to your pool. As soon as wattr detects that a certain device or the wattr system itself is hindered or the system cannot perform its function optimally, this is reported with smart notifications. The notifications are split into heat pump, circulation/filtration, water treatment and system notifications.

The status can always take on 3 values: OK (green), non-serious error (orange), critical error (red). Below are screenshots of an installation where the status is good everywhere. If there is a notification, you can always click on the arrow on the right to view the details.

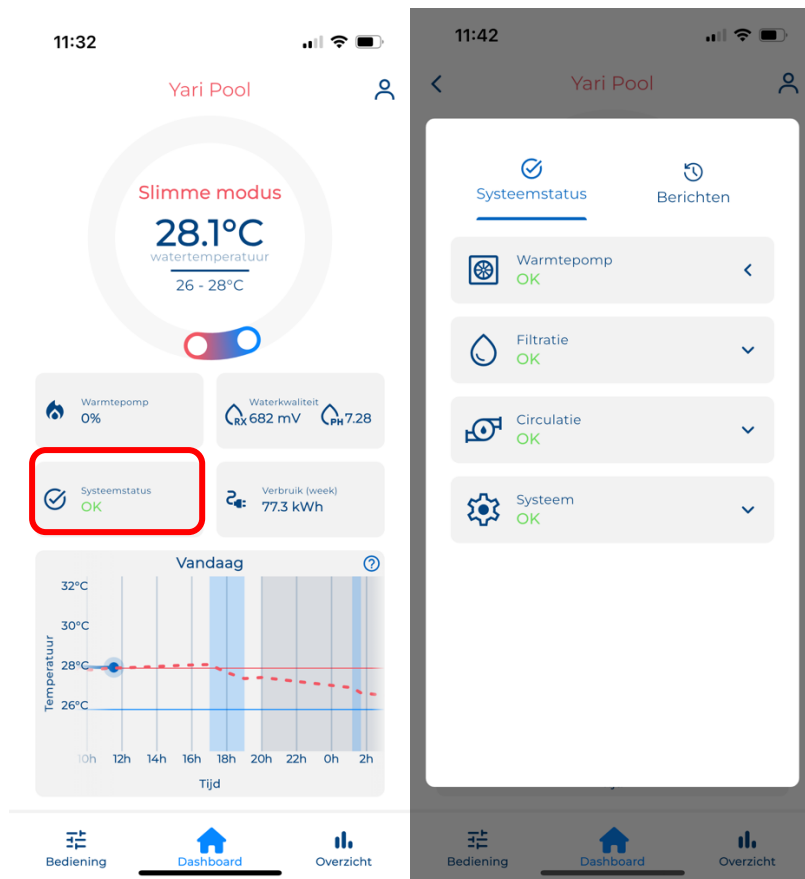

With the notifications, you can set yourself if you actually want to receive them. These settings can be found in the settings of your user account. For example, you can prevent repeated notifications from being sent in the event of a known problem.

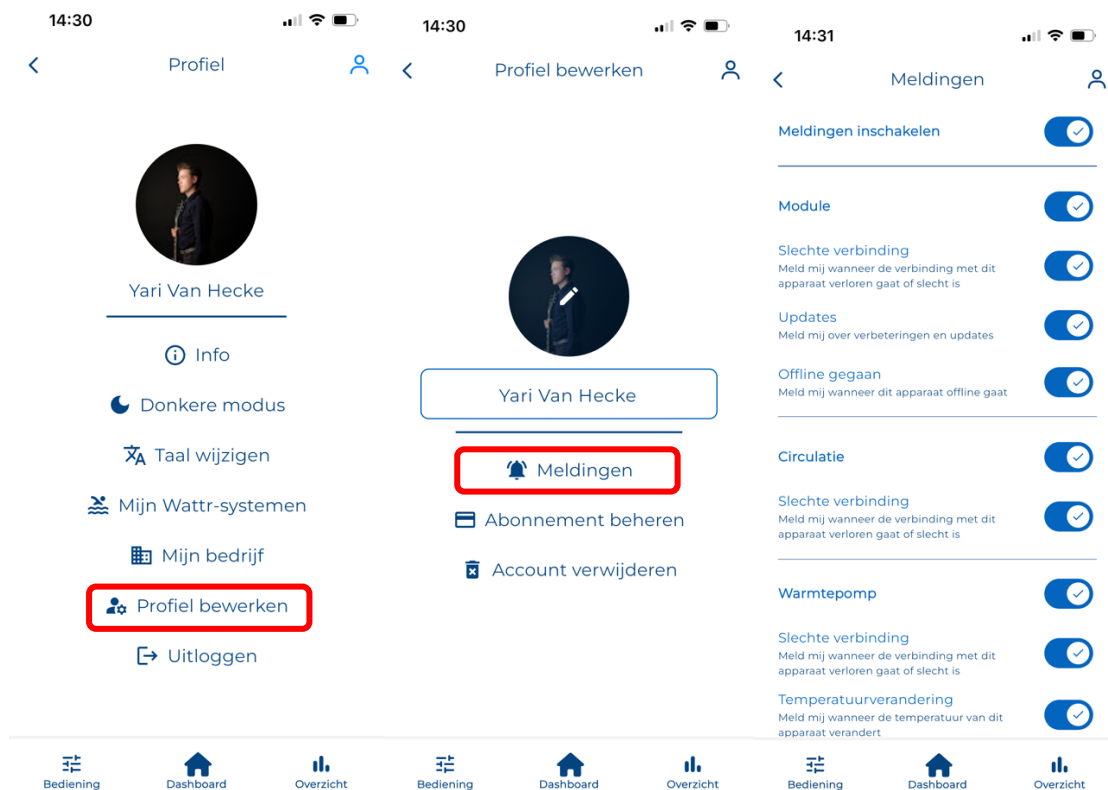

## 3.12. User profiles and system sharing

### 3.12.1. Admin vs user

There are different roles and accounts for the wattr control system. For each pool system in your account, you can either be an administrator or a user.

The installer of a swimming pool is automatically the manager of the pool, when the system is shared with another account it can be chosen if this user should be an administrator or user.

Below is how a pool system can be shared from your profile and how it is then set up if the next user should be an administrator or a user.

Sharing a swimming pool can be done by having the new user scan the generated QR code from his/her wattr application. However, the code can also be copied and sent by mail, message, whatsapp..

An administrator can customize the configuration of the pool system, this is not possible for users. Also, users can't set/edit the PIN code of a cover, for example. You can always easily verify if you are an administrator or user by checking if the edit icon in the form of a pencil is present on the swimming pool system in the application.



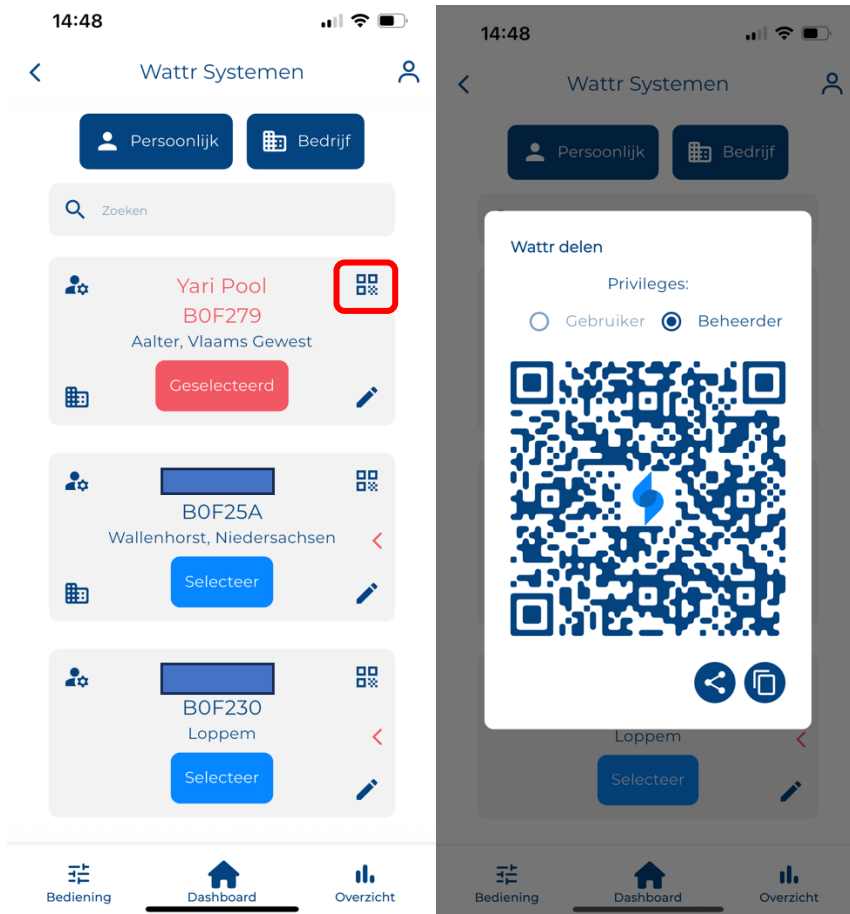

### 3.12.2. Company Accounts

As an installer within a company, you can also register your company within the wattr application. Then, when you add members to this company (for example, colleagues), those members will also automatically have access to the installations you have configured.

In addition, this ensures that customers also see a company icon appear with their installation. When clicking on this icon, the contact details of the company will be visible.

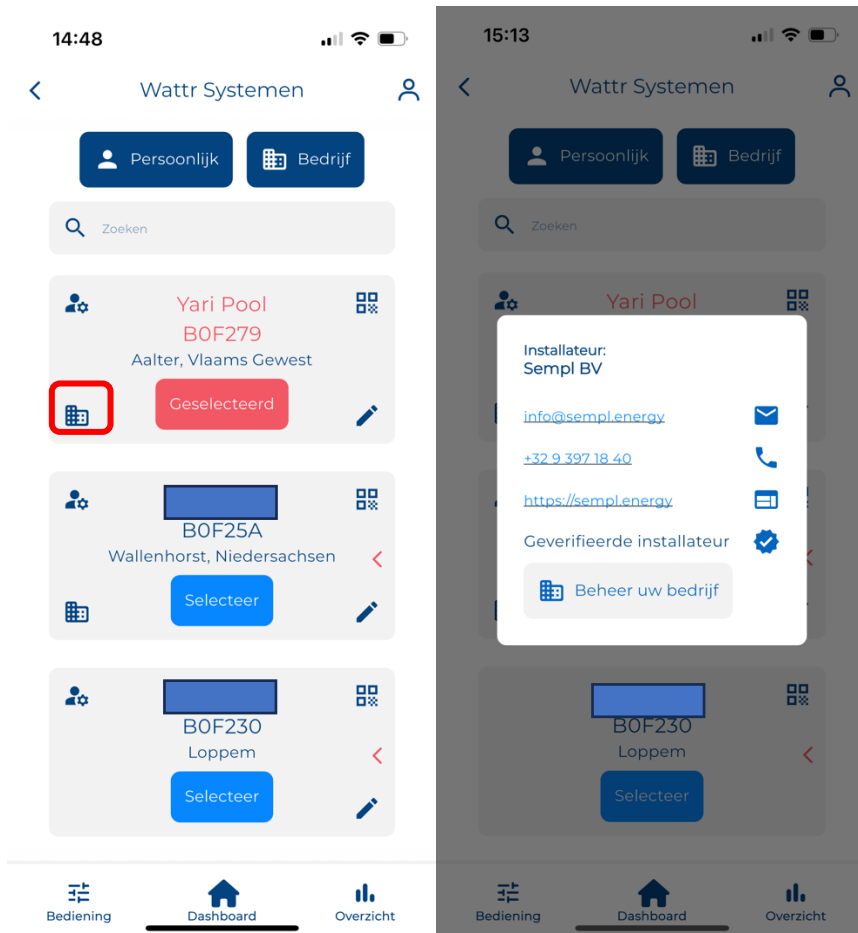

Inviting/managing affiliate accounts to your company is shown below. There are 2 types of accounts within a company: members and administrators. The administrators of a company can add/remove members. This is not possible for members. This ensures that you, as the owner of your business, will be able to retire, leave... a member from the installation of the company to deny access to the installations installed by the company.

On the company page within the wattr application you can also update the contact details at any time.

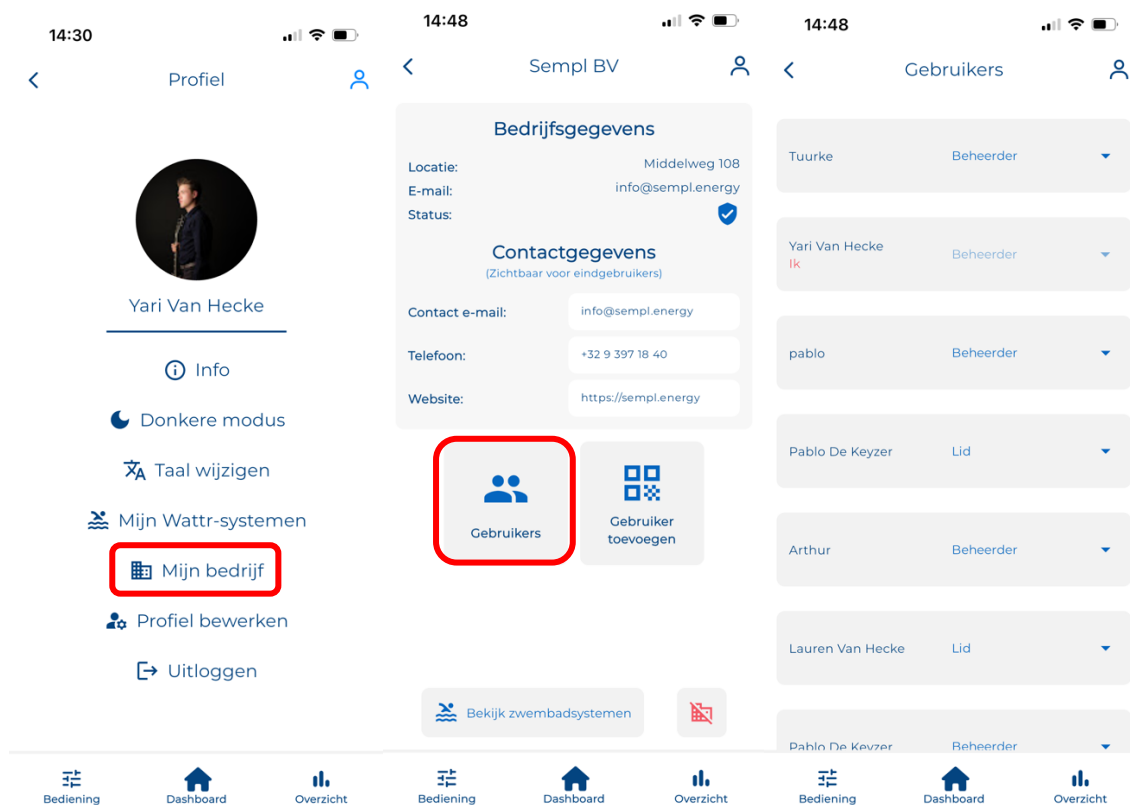

## Opgelet

Before you can use the company account, you must register your company. Wattr checks the data, and after verification, you will be able to access the company's functionalities.

## Safety measures



**Please read the entire manual before installing and activating the module!**

## Attention

- The module must be installed, started, and maintained by a certified electrical installer in accordance with the applicable legal regulations of the country.
- This module is only suitable for DIN rail installation EN50022. The module must be installed in a fireproof, closed junction box with ventilation grilles.
- Before working on the Wattr, the power must be turned off.
- Never connect external voltages (e.g. 230 VAC) to the RS485 bus, this will cause irreparable damage to the module and/or connected devices
- The module must not be opened. The warranty will be void if the module is opened.
- Attention! Not all devices will be suitable for steering. Always check the technical data sheet of the device to be paired.

## 4. Connectors

**Attention: DISCONNECT THE POWER SUPPLY TO THE MODULE BEFORE WORKING ON THE MODULE**

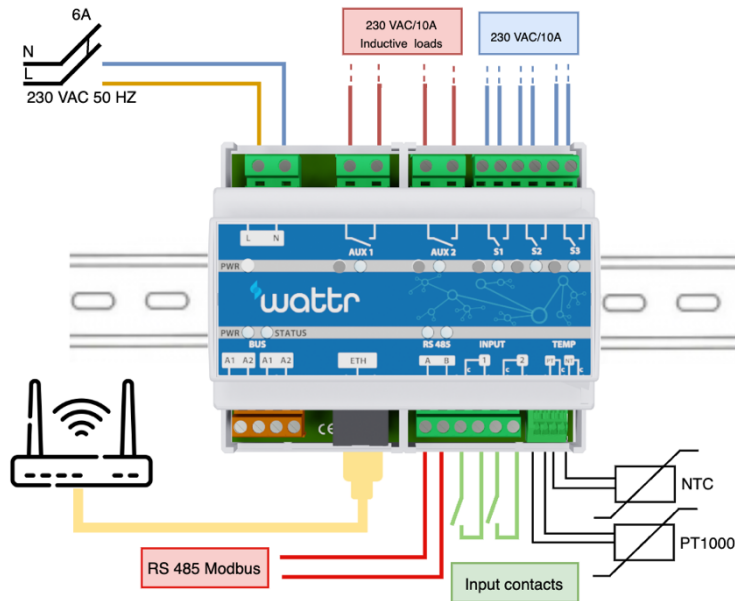

### 4.1. Placement

Click the module onto a DIN rail DIN EN50022. The module must be installed in a fire-resistant, closed distribution box with ventilation grilles.

### 4.2. Power

A two-pole automatic fuse of up to 10A must be connected to the power supply of the 230 VAC module. However, a fuse from 2A is sufficient. Conductor cross-section: at least 1.5 mm<sup>2</sup> at 10A. Remove about 7mm of insulation from the conductor and screw the conductor into the connector L-N.

### 4.3. Relay Contacts

The Wattr is equipped with 5 potential-free contacts, each of which can switch 10A. AUX1 and AUX2 can be used for inductive loads (motors, coils...). The function of each relay can be determined via configuration (backwash, control pump, on/off, pulse, timers). Conductor cross-section: at least 1.5 mm<sup>2</sup> at 10A. Remove about 7mm of insulation from the conductor and screw the conductors into the connectors.

Each relay contact is equipped with a button to test the contact during installation.

### Attention

The button corresponding to the relay contact always takes precedence over the software/app control. A manual action on the button is always exceeded by the next action on the same contact from Wattr.

### 4.4. Modbus RTU (RS 485)

Use the screw connectors to connect the signal lines, A(-) and B(+), of the RS 485 serial communication. The Wattr module uses a two-wire communication, when connecting to a device equipped with a four-wire connection (e.g. A(-), B(+), +12V and GND), unused wires must be adequately shielded. With heat pumps, it is strongly recommended to also use the GND connection, this ensures robust communication.

The use of a shielded bus cable is **strongly** recommended.

Always refer to the manual of the device you want to connect. Later in this manual you will find some examples of how to connect heat pumps and water treatment appliances.

### **Attention**

Certain wattr devices are equipped with an external RS485 filter. This filter should be placed between the module and the bus cable to ensure robust communication. If this module is not supplied, this filter is already provided in the housing. Follow the instructions on the filter packaging for proper placement.

### **Attention**

Never connect external voltages (e.g. 230 VAC) to the RS485 bus, this will cause irreparable damage to the module and/or connected devices

### **Remark**

RS 485 uses a bus structure, so multiple devices can be connected to the Wattr module's Modbus RTU socket.

## **4.5. Ethernet**

Connect the network cable to connect the Wattr module to the local network. The use of powerline adapters is strongly discouraged. The use of a 4G router is recommended if there is no or an insufficiently stable network available.

### **Attention**

The Wattr pool controller does not function properly without a network connection.

### **Attention**

The use of powerline adapters is strongly discouraged. The use of an inverter heat pump can interfere with the operation of these adapters, preventing a reliable internet connection.

## **4.6. Input contacts**

The Wattr module is equipped with 2 input contacts for connection with potential-free contacts. The maximum cable length for the connection is 50m.

### **Attention**

Always use potential-free contacts.

## **4.7. Temperature sensors**

The Wattr module is equipped with an input for an NTC temperature sensor and a PT100 temperature sensor. Connecting temperature sensors is not necessary for the operation of the Wattr system. If this is necessary for a certain functionality, this will be indicated during configuration in the app. If no sensors are connected, the sensors in the heat pump are used to measure the water temperature.

## 5. Connection devices

This chapter explains the connection of various devices.

### 5.1. Heat pump

In order for the Wattr pool controller to work properly, it must always be connected to a compatible heat pump. The list of compatible heat pumps can be found in Compatible Devices.

Refer to your heat pump's documentation to find the position of the Modbus RTU (RS485) connector. This is usually marked A, B, G, +12V. In some types of heat pumps, the connector is located near the power connection, in others it is present on the circuit board. In the box of the Wattr module, you can find several connectors that are used for connection to the circuit board.

Below are 2 examples of commonly used heat pumps.

#### 5.1.1. Fairland/Aquark heat pump

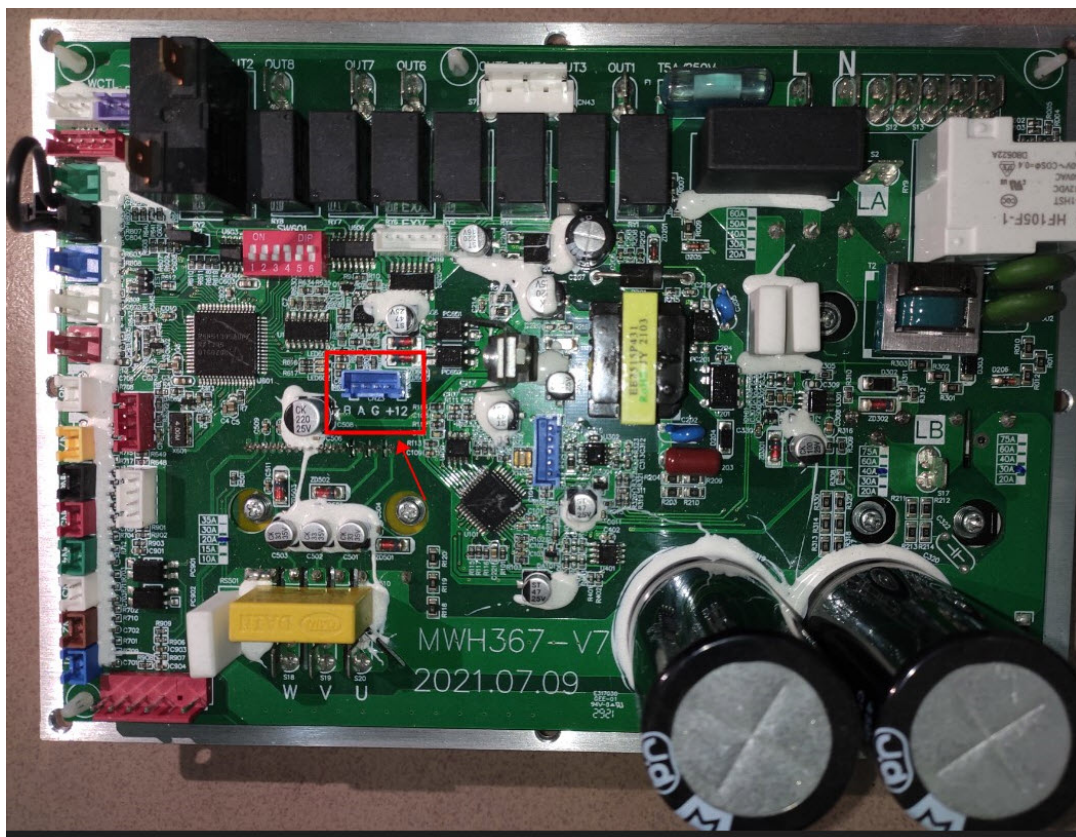



### 5.1.2. PHNIX heat pump

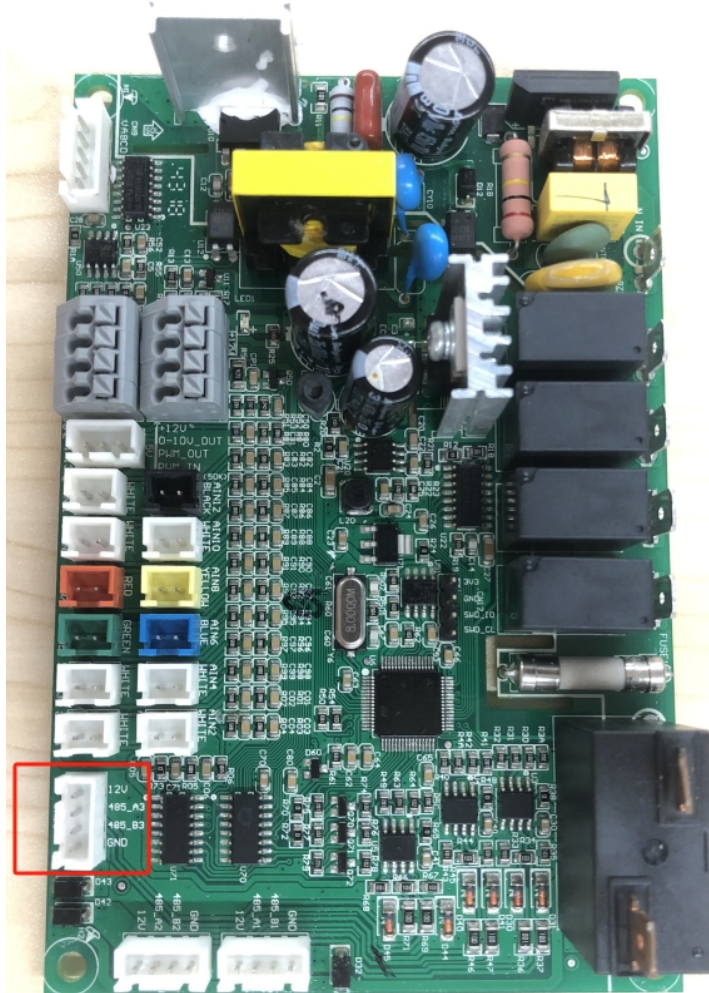

## 5.2. Water treatment

### 5.2.1. Connection using RS485 Modbus

In order to read out and visualize the water values in the Wattr application, the water treatment device must also be connected to the Wattr module. Most water treatment devices support communication using Modbus RS485. The following are the installation instructions for different brands/types of water treatment.

#### **Connection Sugar Valley, Da-Gen, Aqua Easy Station**

The device can be connected using the connector provided, use the appropriate output of the device "RS 485 Modbus" and screw the conductors into the RS 485 connectors of the Wattr module.

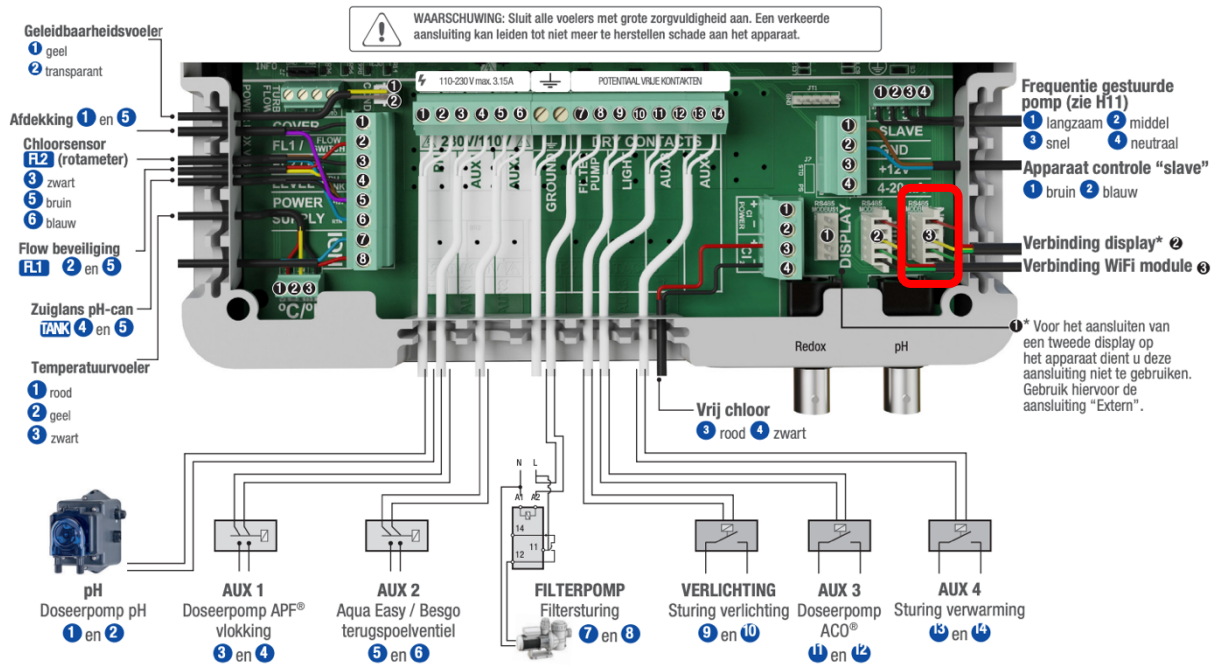

## Attention

Always be aware of the RS-485 A and B terminals; the diagram below shows which pins of the 5-pin connector correspond to the A and B terminals. Always adequately shield unused connectors from the connector! The "WIFI" or "EXTERNAL" connection can be used, do not use the "DISPLAY" connection!

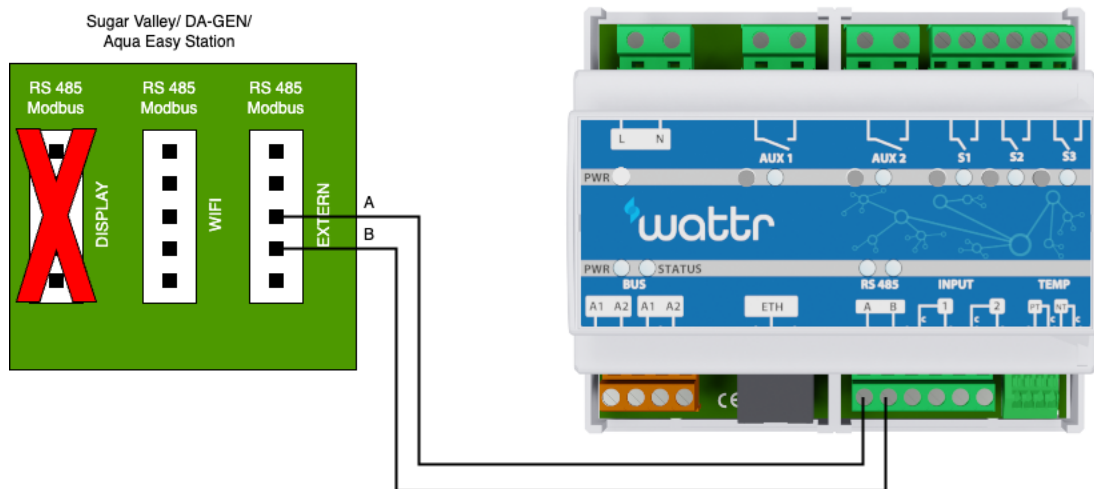



## Idegis

No additional connector is required for connecting Idegis water treatment devices. The connection can be made directly to the plug-in connectors present on the PCB of the Idegis device as indicated below.

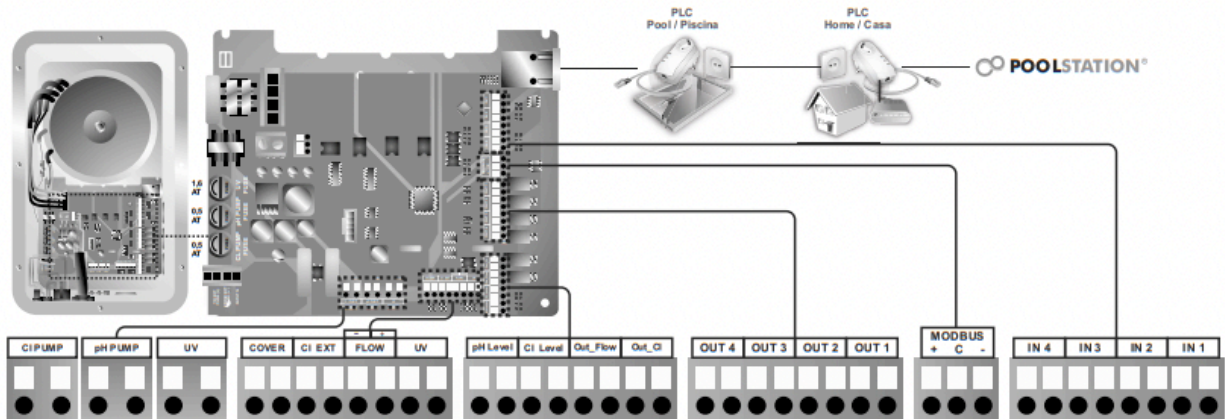

## Aquark Mr Pure

The Aquark Mr Pure devices are equipped with a modbus RS 485 connection, which can be found at the bottom of the device. The required cable is supplied with your water treatment system. In the absence of the cable, ask your distributor.

Below is a schematic diagram of how to establish the connection with the Watrr controller.

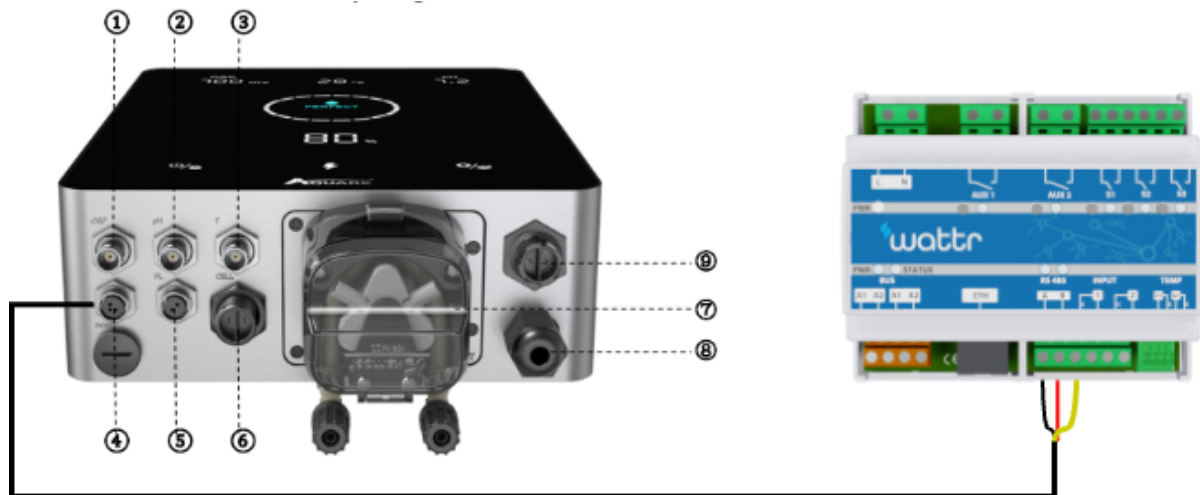

## **PoolSquad**

PoolSquad devices are equipped with a Modbus RS485 connector. When connected to the Wattr connector, Wattr can communicate with the PoolSquad. The modbus connector can be found at the bottom of the PoolSquad controller.

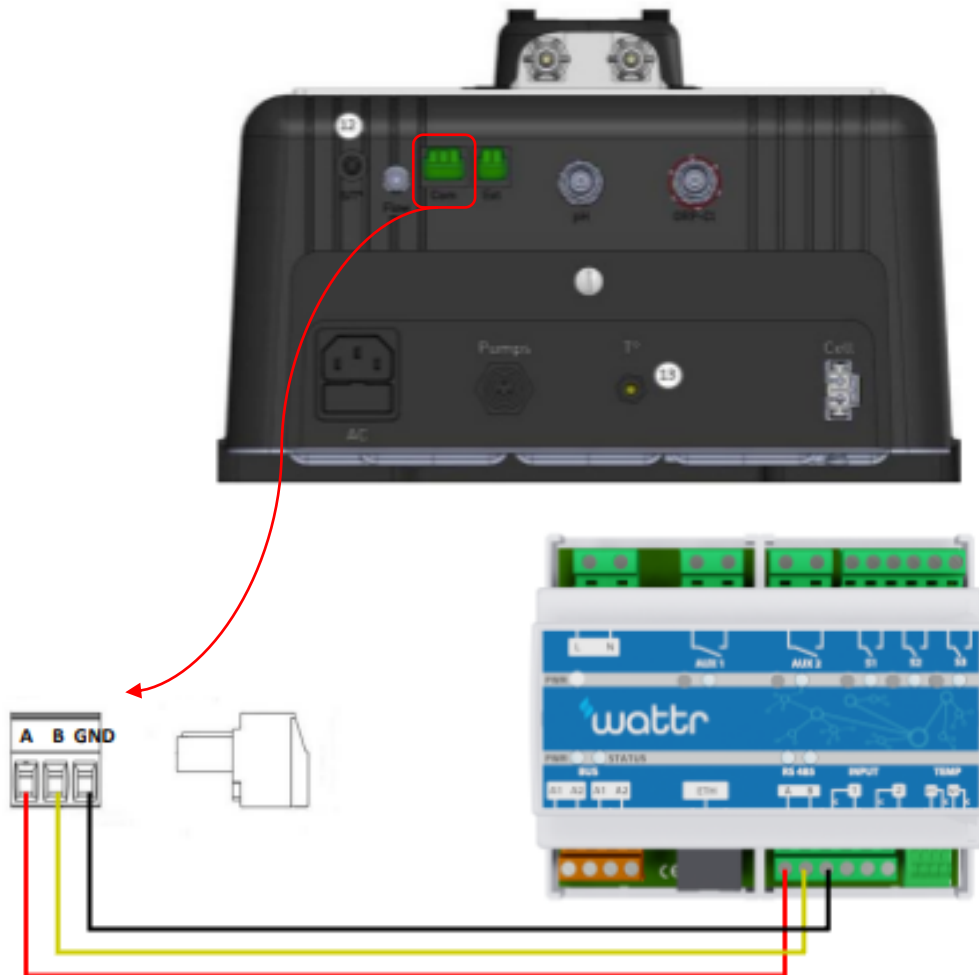

### **5.2.2. Wireless Connection**

Some water treatment equipment allows a wireless connection (using the internet connection). The following is shown on how to make the connection for these water treatment appliances.

## **Aseko**

Wattr is compatible with Aseko water treatment equipment if it is equipped with an internet connection and can be monitored from the Aseko application. First identify your water treatment device in the Aseko application and then use your login details and serial number to connect the device to the Wattr application as well.

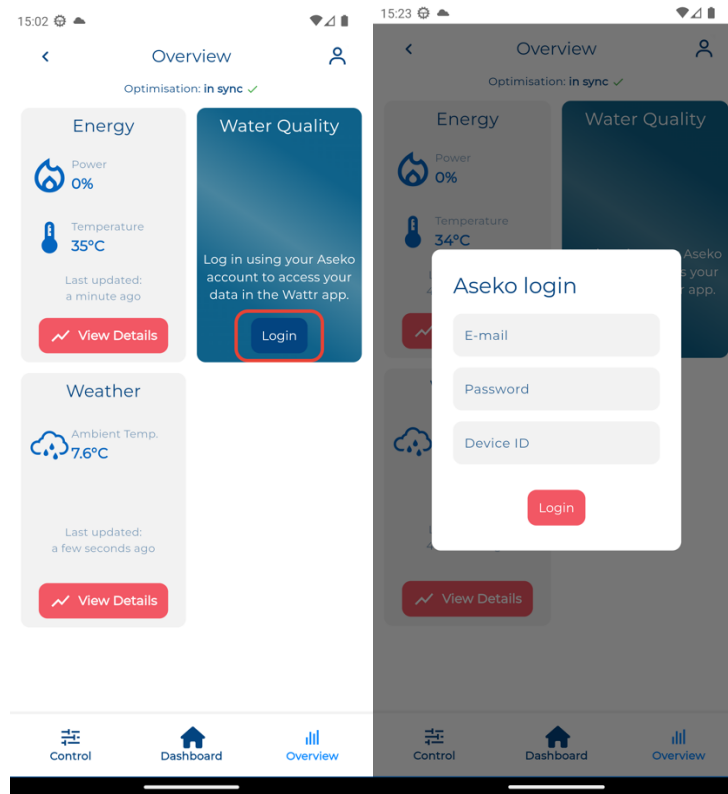

### Attention

If the water treatment device is also used to control the variable speed circulation pump, the Wattr module will control the pump through the water treatment device. In this case, the circulator should not be connected directly to the Wattr module.

### Attention

The Wattr module is not a water treatment device, so there is always a need for an external water treatment system. Always check the manual of this appliance for correct installation and operation.

### Attention

Connection to a water treatment device is not necessary for the operation of the Wattr system. In this case, however, the water quality cannot be monitored. If the water treatment device is not connected, it is necessary for the Wattr module to directly control the variable speed circulation pump, see also Circulation pump connection

### Attention

Make sure that the water treatment device is equipped with a power protection device when the device is not connected to the Wattr controller. Please refer to the manual of your water treatment device.

## 5.3. Circulation pump

Wattr controls variable speed pumps via a connected water treatment device or directly via the Wattr module. When connected directly to the Wattr module, there are 2 options: control via potential-free contacts (digital inputs) or via Modbus RS-485.

### Attention

Always refer to your pump's manual to ensure a correct connection.

#### 5.3.1. Control with potential-free contacts

By controlling the circulation pump using 3 potential-free contacts, 3 pre-programmed speeds can be set. Refer to your pump manual for programming the rotation speeds.

It is strongly recommended to use contacts S1, S2 and S3. This ensures that the contacts AUX1 and AUX2, which can also switch inductive loads, remain free.

For speed 1, Wattr will energize contact S1, for speed 2, Wattr will energize contact S1 and S2, for speed 3, Wattr will energize contact S1, S2 and S3.

Below is an installation example with a Speck Badu Delta Eco VS. (black = GND, red = stop, brown = speed 1, green = speed 2, white = speed 3) At low rpm only the contact S1 is energized, at medium speed S1 and S2 are energized. At high speed, S1, S2 and S3 are energized.

### Attention

Make sure to connect the low speed to S1, the medium speed to S2, and the high speed to S3.

### Attention

Program the correct switching behavior for the so-called stop conductor (red conductor in the example below). In the example below, the pump should be programmed so that the motor stops at an open contact between the red conductor and GND.

### Attention

When the stop guide is not in use, it must be adjusted accordingly on the pump, unused conductors must always be adequately shielded.

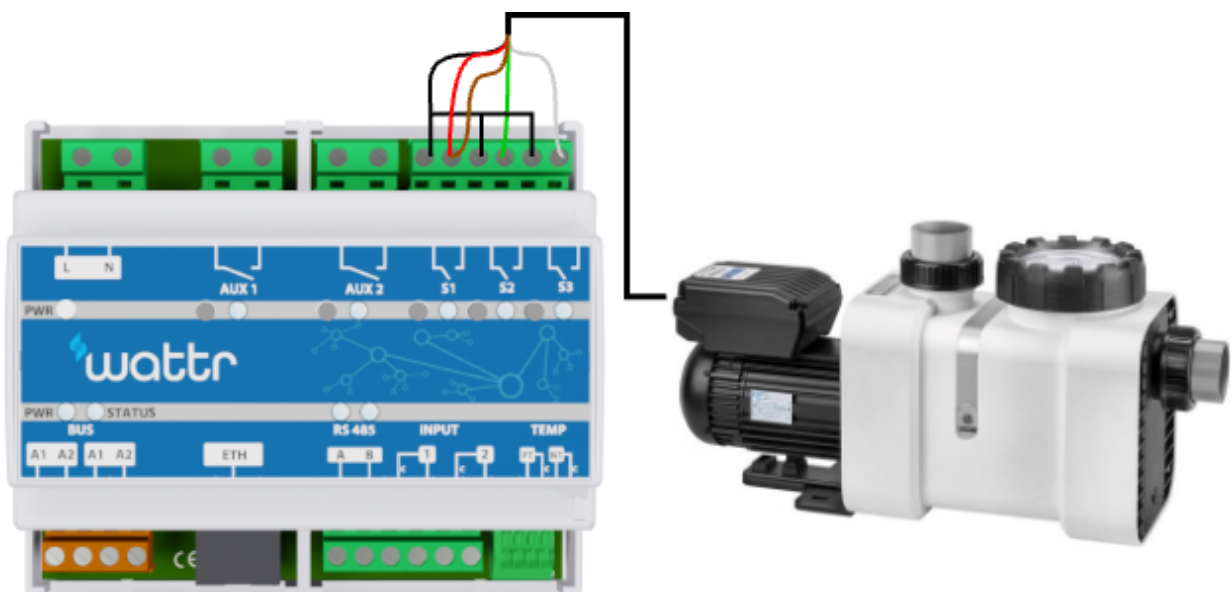

## Attention

With certain pumps, the stop behaviour cannot be programmed. If a closed connection between the ground and the stop conductor is required to stop the pump, an additional switching contact/changeover contact (e.g. in the form of a DIN rail module) must be used. This additional switching contact must be energized via contact S1 of the Wattr module. Speed 1 is then connected to the NO contact of the additional switch and the stop conductor to the NC contact. If S1 is not live, the changeover contact is also not energized, so that the stop conductor is connected to ground thanks to the NC contact (normally closed).

### 5.3.2. Control with Modbus RS-485

If the circulator can be controlled with Modbus RS-485 and the pump is compatible with Wattr, the RS-485 connection on the Wattr module can be used. The following is an installation example with an Aquagem Inverpro. Always refer to the pump manual to check which conductors/connectors correspond to the A and B conductor for RS-485 communication

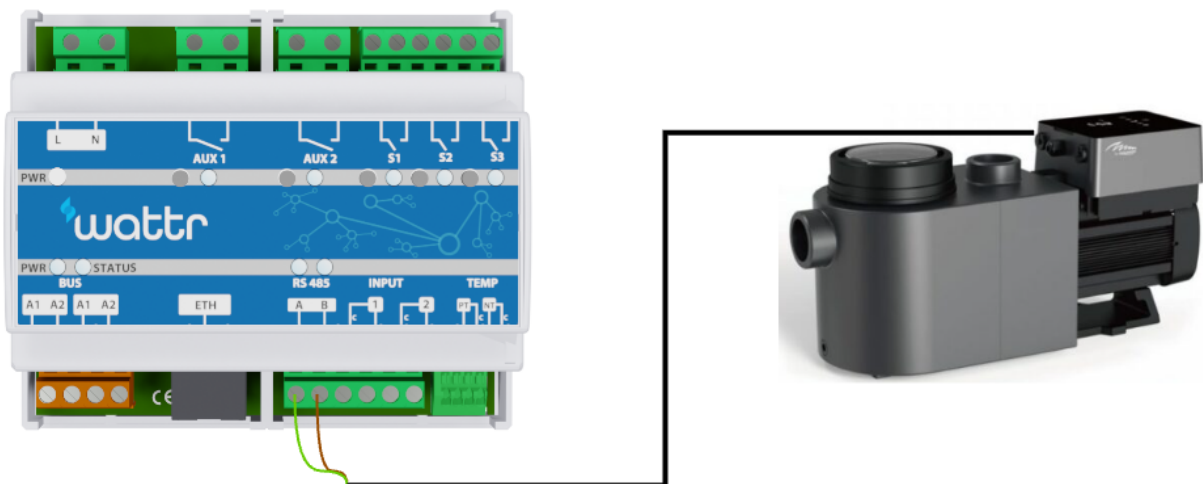

## Attention

Always check if your pump is equipped with RS-485 control, this form of control is optional with some pumps

## 5.4. Cover

### 5.4.1. Status readout

To ensure proper operation of the Wattr control, it is necessary to read the status of the cover using a Wattr module input. This way, the Wattr module knows when the cover is open or closed and the system can take this into account. With the help of 1 of the input contacts of the wattr controller, the controller of the cover can be read. Below you can find an example of the Aquadeck controller.

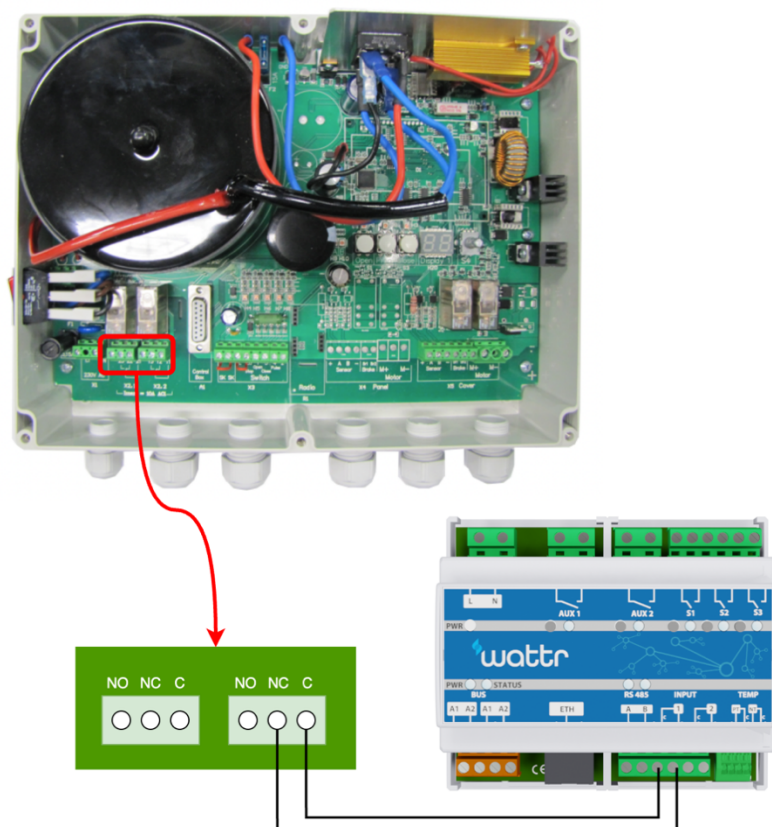

## Attention

Always check the meaning of a closed or open contact on the controller of your cover. (open contact = cover open or open contact = cover closed). Also indicate this correctly when configuring in the Wattr application.

### 5.4.2. Controlling the cover

Wattr can also control your automatic cover. This is done with the help of a relay contact that is set to send out pulses. To do this, connect the respective relay contact selected in the configuration to the corresponding input of the controller cover. Below you can find an example where AUX1 is used to control an Aquadeck cover.

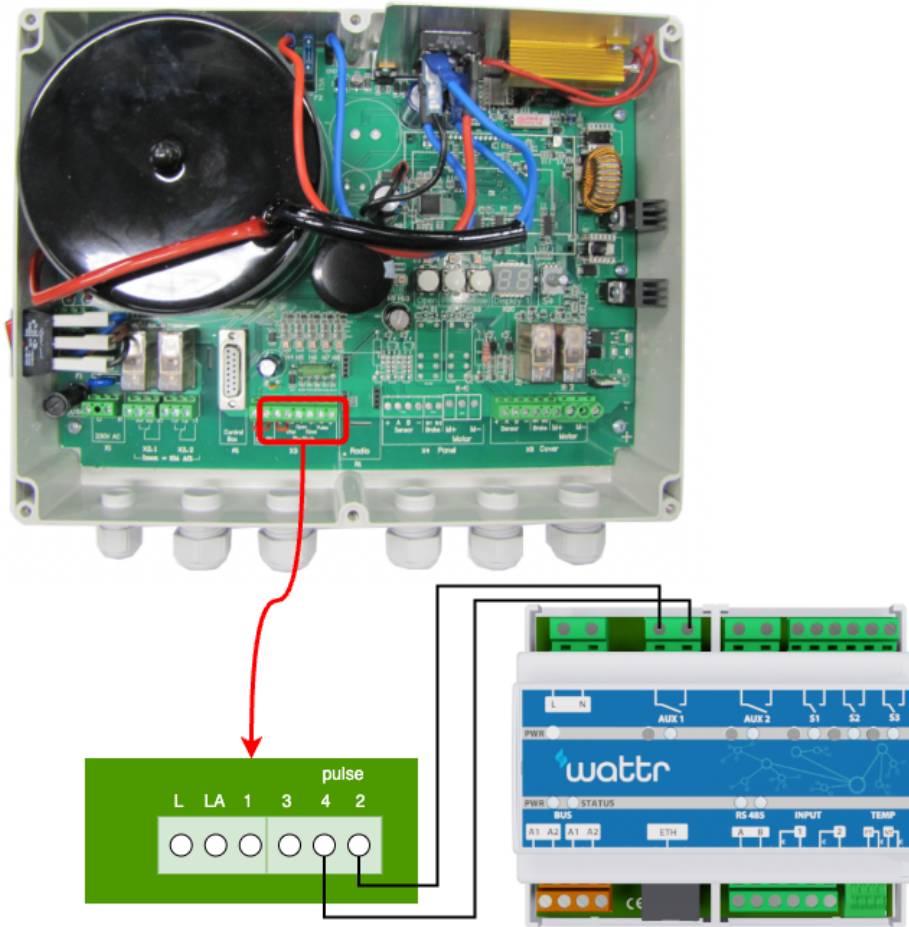

**Attention**

Always check the manual of your cover to verify if control is possible using 1 pulse contact.

**5.5. Lighting connection**

5.5.1. Using relay contacts

Below is an explanation of how the contacts can be used to control the lighting. In the first example with Eva Optic lighting, contacts S1 and S2 are used to turn the lighting on or off and change color. To do this, the contacts used are set to send pulses during configuration in the app. To enable such control in combination with Eva Optic illumination, the dials on the circuit board must be set to the indicated values 6-0-5. Always consult the installation manual of your lighting before connecting it to the Wattr module.

**Remark**

In the example below, the AUX contacts were not used. When the Wattr module does not require contacts S1, S2 and S3 to control the circulation pump (pump is controlled via water treatment or RS-485), the contacts can still be used for other purposes. This is set during configuration in the Wattr application.



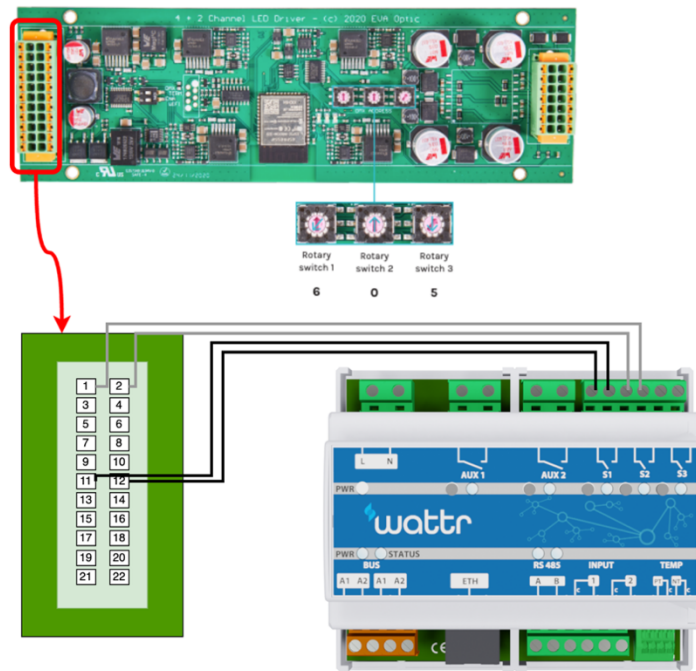

*Installation example Eva Optic lighting*

Below is another example of how to connect lights with Vision Adagio Pro bulbs. Here, the AUX-1 contact cuts off the power supply to the transformer. This allows the lighting to be switched On/Off. Color change is also possible, this is obtained by briefly turning the lighting off and on again.

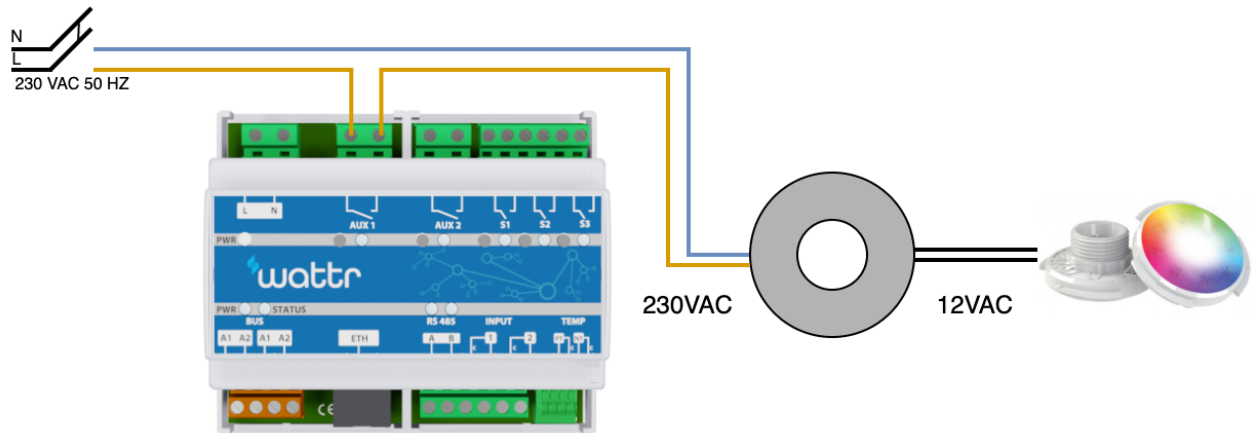

### 5.5.2. Using RS485

Certain brands/types of lighting allow to be controlled using RS485. This often provides more options in terms of color choice, brightness, etc. Such lighting must also be connected to the RS485 port of the Wattr module, with 1 of the 2 conductors of the RS485 cable one must place a relay contact of your choice. This contact only switches on when the lamps are controlled.

Below you can find an example with the PLP REM 350 from Duratech.



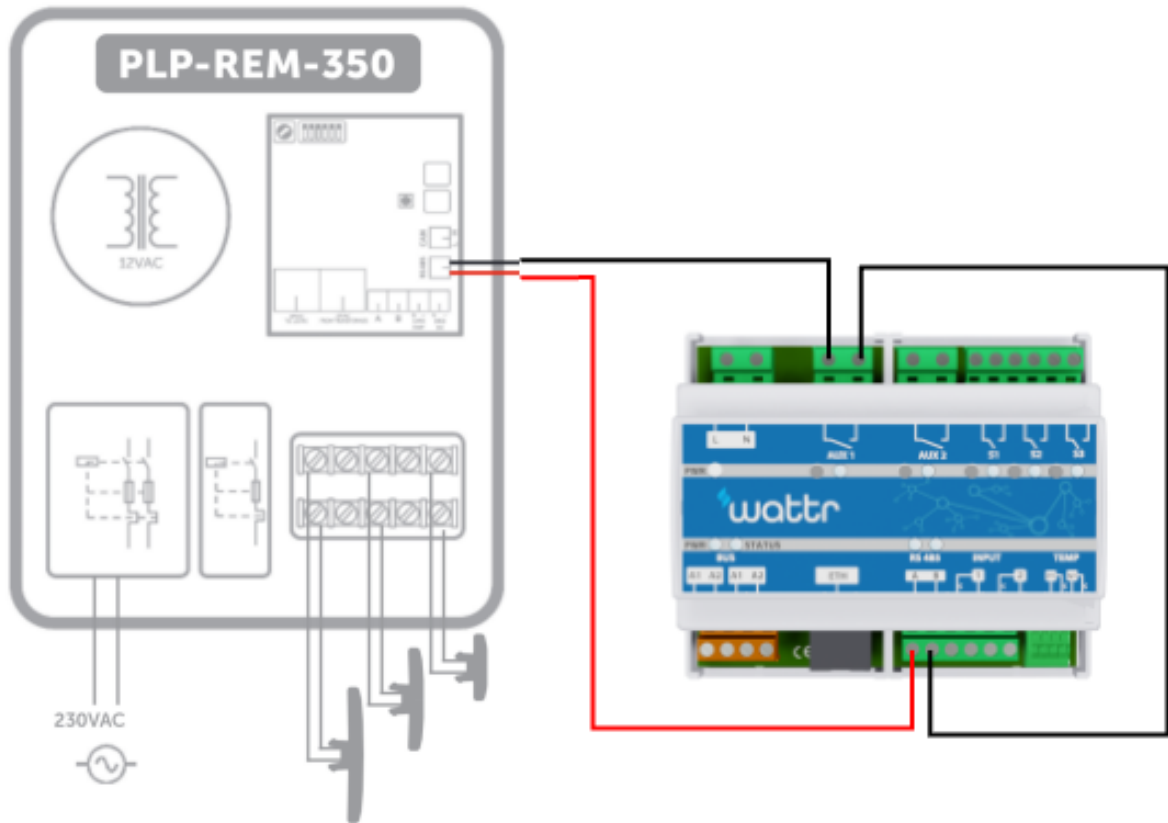

### Remark

Always refer to the manual of the installed lighting to ensure correct installation.

### Remark

Also when connecting lighting using RS485 one should pay attention to the correct polarity of the 2 wire communication, the A and B wires must be connected accordingly.

## 5.6. Connection Besgo valves

Besgo valves can be connected to obtain various functionalities such as backwashing the sand filter, switching on the overflow effect of an overflow pool, etc. The wattr controller uses 1 of the relay contacts for this, you can select this contact yourself during the configuration in the application. Below you can find a connection example where AUX 1 is used to control the valve.

230 VAC

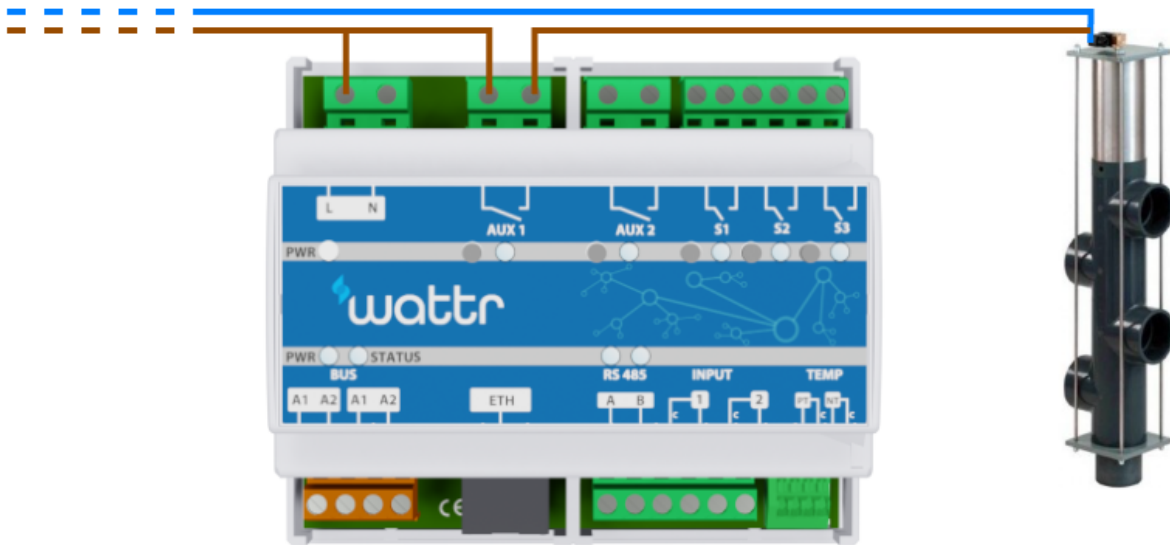

### Remark

During configuration in the wattr application, you can select a number of standard functionalities, including overflow and backwashing. If you plan to use 1 of these functionalities, you must also select it correctly in the application. In the event of a backwash operation, Wattr will also switch off the pump before the valve is controlled.

## 5.7. Water level control connection

The Wattr controller can perform a simple water level control in combination with a float and a valve. The connections are shown using the example below. In this example, input 2 is used to connect the float and AUX2 is used to energize the valve that shuts off the water supply to the pool.

### Remark

Always take into account local legislation when connecting your pool to the water network.

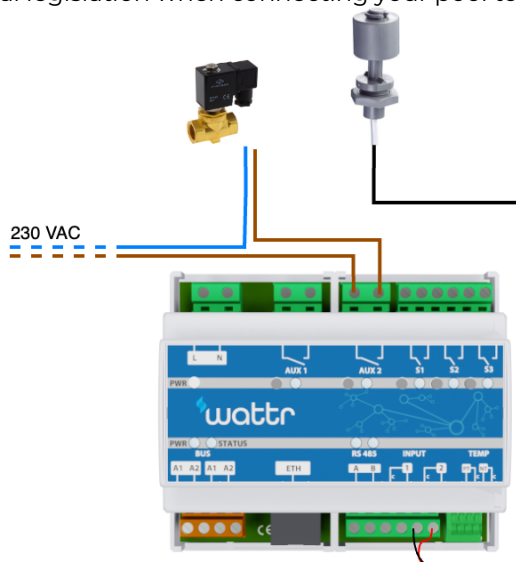

## 5.8. Connection to other devices

Above, the connection examples of the most commonly used/pre-programmed functionalities were discussed. However, it is always possible to give the relay contacts of the wattr module a general functionality according to 1 of these 3 possibilities:

- On/Off
- Timer
- Pulse

This allows you to add your own capabilities to control other devices. (e.g. water attractions, counter-current systems, etc.)

### Attention

Always check the manual of the device you wish to operate with the wattr controller before connecting.

## Configuration

The following clarifies how to configure the Wattr controller after installing the module. Turn on the module and check if the PWR LED lights up green, also check the network connection using the LED lights in the Ethernet port. Make sure the wiring is complete before starting the configuration in the app.

### 5.9. In-app configuration

Install the Wattr app on iOS or Android and create an account. Upon startup, you will see the screen below. Here, click on "Configure a new operating system". If it's not your first setup, go to Account -> My Wattr Systems and then click the plus sign at the bottom to bring back the screen below.

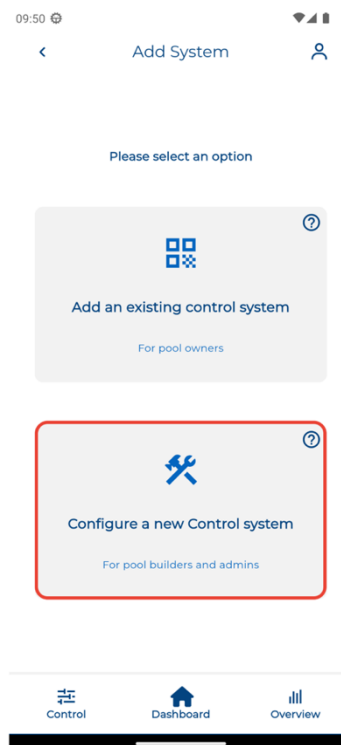

The configuration is done in 3 steps. In the first step, you scan the code present on the Wattr module. If scanning fails, you can always enter the serial number and activation code manually. The text lights up if the Wattr module is known and the code is correct. Next, enter the name of the installation, which is visible when using the app, and the location of the pool. (A correct location is necessary for the use of weather data). Before proceeding to the second configuration step, the internet connection is checked. Make sure that the wattr module is already connected and switched on.

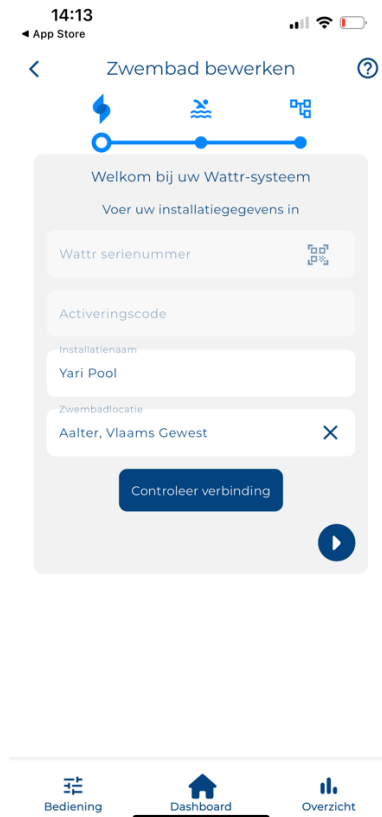

In the second step, you first fill in the dimensions of the pool. Then click on the drop-down menu to select the cover that best suits the pool cover. In the case of an automatic cover, you then indicate which input contact is connected to the control of the cover. Furthermore, it is also requested if the cover is currently open or closed, this is to check if a Normally Open (NO) or Normally Closed (NC) contact is used on the control box of the cover.

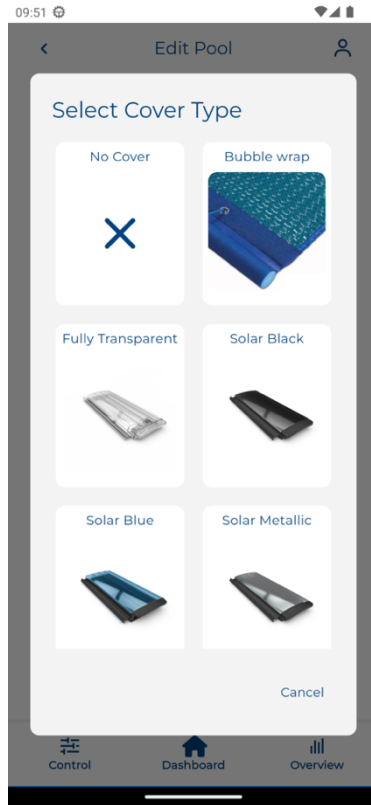

During the second configuration step, you also indicate the dimensions of your pool. If your pool is not rectangular, you can enter the volume and average depth.



In the last step, it asks which devices are connected to the Wattr module. To do this, you must first enter the heat pump, then the circulation pump and the water treatment. When a device has been connected using Modbus RS 485, the connection is checked before you can proceed to the next configuration step. If a connection error is detected, check the cabling and network connection.

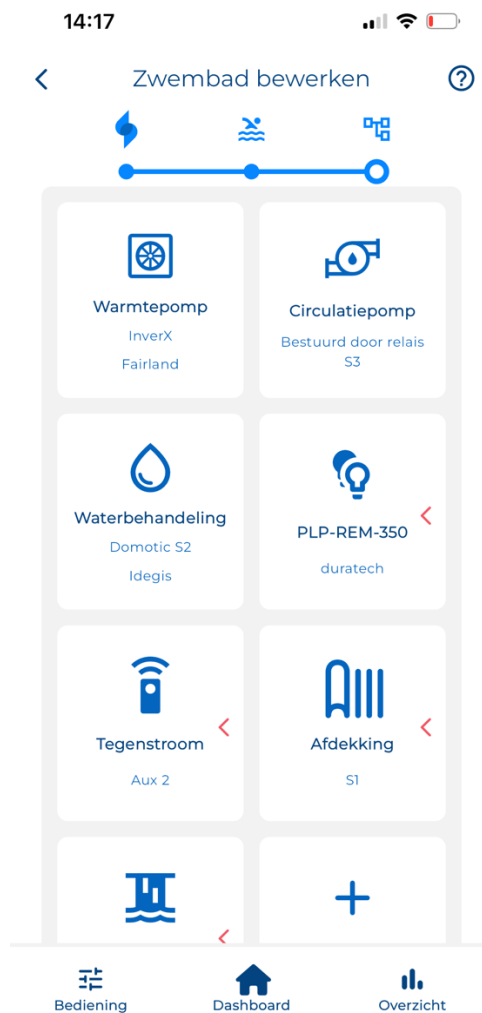

When the heat pump, circulation pump and water treatment have been configured, you can configure the additional functionalities by pressing the "+" button. Then select the functionality you wish to add. Certain functionalities can only be set 1x, if you try this a second time you will not be able to select them again. Incorrectly entered devices can always be removed using the red arrow.

The Wattr app asks a number of questions for each functionality (e.g. which contacts, inputs were used) to guide you through the configuration. If something is not clear, you can always press the "help" icon.

In addition to the pre-programmed functionalities: Cover, overflow, backwashing, level control and coloured lamps, you can also set general functionalities under "other": switching or on/off, pulses and timers.

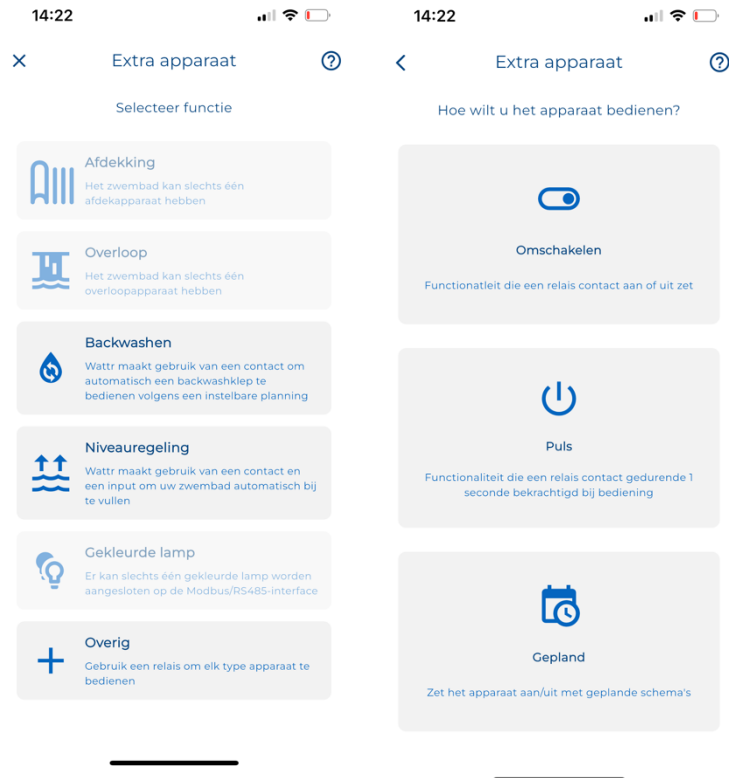

When the configuration is allowed to be completed, click "Configure". The Wattr controller can now be used to control your pool.

## 5.10. Installation Sharing

After successful configuration, you can select 'My Wattr Systems' via your account. You'll then get a list of all the Wattr systems associated with your account. For each Wattr system, you can generate a QR code in the top right corner. You can also use the 'share' button to easily share the code when the end user is not present.

The end user needs to create an account on the Wattr app. Then, the end-user clicks on 'Add an existing operating system' to scan the generated QR code. When the scanning is completed successfully, the system will be added to their account. The end-user can share control of the pool with family members, friends, etc., in the same way if they wish.





Please select an option



**Add an existing control system**

For pool owners



**Configure a new Control system**

For pool builders and admins



Control



Dashboard



Overview



## Compatible devices

Below is a list with an overview of compatible heat pumps and water treatment systems. This list is constantly expanding, so always check the website [www.wattr.energy](http://www.wattr.energy) to access the latest version.

Please contact your distributor if you have any questions.

### Attention

It is necessary that your heat pump is compatible with the Wattr control system for the system to function properly. It is not necessary for your water treatment system to be compatible with the Wattr control system; in this case, the water treatment system must be equipped with a flow switch and the circulation pump must be controlled by the Wattr module.

#### 5.11. Heat pumps

Brand	Type
Pool Power Package	VBIV
Pool Power Package	VBEX
Fairland	Inverter+
Fairland	InverX
Fairland	Comfortline
Aquark	Mr. Silence
Aquark	Mr. Perfect
Norsup	PX
Norsup	BEERS

#### 5.12. Water treatment systems

Brand	Type
Sugar Valley	Oxilife
Sugar Valley	Station
Sugar Valley	Hidrolife
Sugar Valley	Aquascenic
Sugar Valley	UV Scenic
Sugar Valley	Bionet
Sugar Valley	Hidronize
Aqua Easy	Station
Dryden Aqua	From-Jan
Hayward	Aquarite
Idegis	Domotic S2
Idegis	Neo S2
Idegis	Control S400
Aseko	Watersens NET
Aseko	Watersens SALT
ASEKO	Watersens HOME
Aquark	Mr Pure
Pool Technologies	PoolSquad

#### 5.13. RGB controlled lamps (color wheel)

Brand	Type
Duratech	PLP REM
Duratech	PLP REM 350